



**TURNING MOTION
INTO STRENGTH**



KIAN HO GROUP

建和轴承油封
Bearings & Seals



70 Years of Operations





KIAN HO GROUP

OUR AUTHORISED PRODUCT BRANDS

拥有授权经销权的产品品牌

IKO

EZO

NSK

KURODA
JENATEC

NOK

Hallite

SAKAGAMI KHS

SAKAGUCHI
ELECTRIC HEATERS

AirTAC
Pneumatic

WON
SHAFT



DAIDO METAL



NTN

UBC

OTHER AVAILABLE BRANDS

我们销售的其他品牌

JTEKT Koyo



FAG

Parker



KIAN HO GROUP

CORPORATE OVERVIEW 企业介绍

Kian Ho Pte Ltd (“KHS”) located in Singapore, is a wholly-owned subsidiary of Raffles United Holdings Pte Ltd (“RUH”) formerly known as Kian Ho Bearings Ltd which was founded in 1956. Kian Ho Group (“KHG”) is known as one of the largest stockists, distributors and retailers of linear motion, bearings and seals products in South East Asia and beyond. KHG caters primarily to the wholesalers, replacement markets and Original Equipment Manufacturers.

建和私人有限公司(简称“KHS”)位于新加坡,是莱佛士联合控股私人有限公司(简称“RUH”)的全资子公司,前身为1956年创立的建和轴承有限公司。建和集团(简称“KHG”)是东南亚及其他地区最大的直线运动系列、轴承和密封件产品经销商、分销商和零售商之一。KHG主要服务于批发商、维修市场和原厂设备制造商。



SINGAPORE HEAD OFFICE



CORPORATE OVERVIEW

Kian Ho Group focuses on the ASEAN and China markets, with operations across five ASEAN countries and China. We are committed to delivering high-quality products as a one-stop solutions provider, offering a comprehensive range that includes linear motion guides, bearings, seals, electric vacuum heaters, shafts and pneumatic products to our customers across the regions we serve.

In line with this, we have expanded our product portfolio to include SAKAGUCHI electric vacuum heaters, AirTAC pneumatic products and WON shafts offering complementary solutions to better serve customers across a wide range of industries. We strive to forge long-term, win-win partnerships with all our suppliers and customers, founded on mutual trust, open communication and exceptional service.

We have embarked on a transformative digitalisation journey, revitalising our Group operations through technology and automation to enhance efficiency and create lasting value. At the same time, we are deeply committed to developing our employees to their fullest potential, providing meaningful opportunities for growth and progression within our Kian Ho Group.

Our Singapore headquarters is equipped with an Automated Storage & Retrieval System (ASRS) designed to optimize KHG's overall inventory management and operational efficiency. This centralized system supports our general inventory requirements, while each subsidiary and branch maintains dedicated local stores to ensure responsive service, flexibility, and reliable on-time delivery to our customers.

Building on our 70-year legacy as a trusted and reputable company, we aspire to be a global partner of choice, serving our customers with the highest standards of integrity, sincerity and humility.

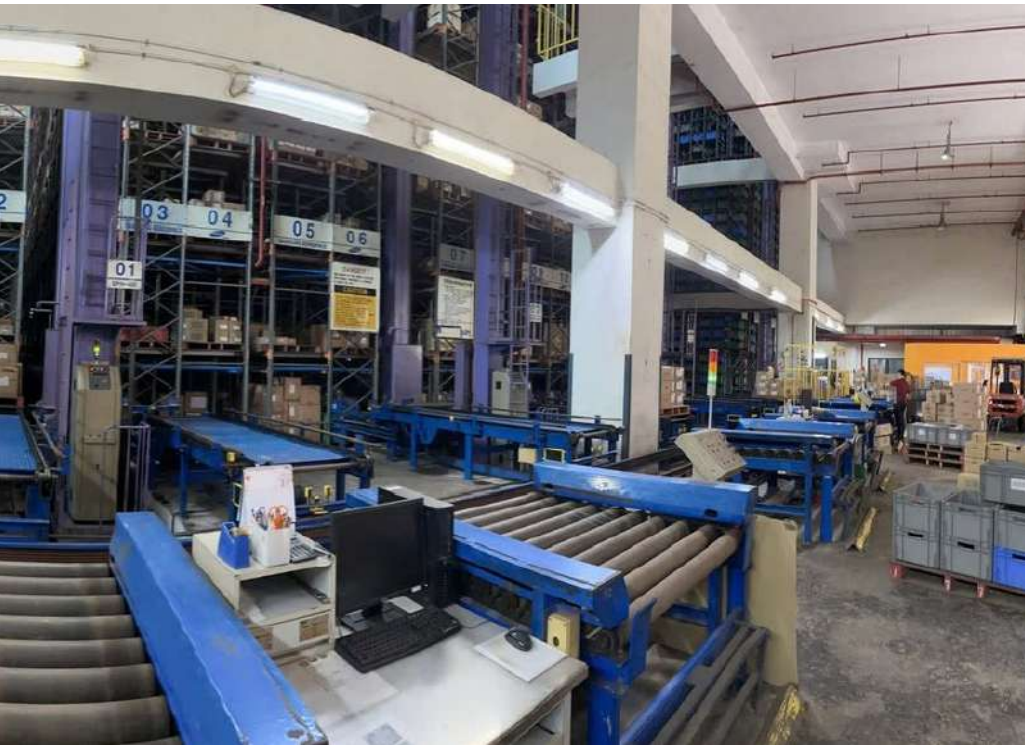

企业介绍

建和集团专注于东盟和中国市场，旗下子公司分布于东盟5个国家及中国。我们致力于为客户提供高质量的产品，作为一站式解决方案提供商，我们向我们所在地的终端用户客户提供直线运动导轨、轴承、密封件、电真空加热器以及气动产品。

为此，我们扩大了产品范围，新增了坂口电真空加热器、亚德客气动产品和万思特直线运动轴，旨在为各行各业的客户提供互补的解决方案，从而更好地服务客户。我们致力于与所有供应商和客户建立长期共赢的合作伙伴关系，以互信、公开沟通和卓越服务为基础。

我们已经开启数字化转型之旅，通过技术和自动化重塑集团运营，提升效率，创造持久价值。与此同时，我们致力于充分挖掘员工潜力，为员工在建和集团内部提供有意义的成长和晋升机会。

我们的新加坡总部配备了一套自动化仓储与检索系统(ASRS)旨在优化 KHG 的整体库存管理和运营效率。这一集中化系统能够满足我们的一般库存需求，而各子公司和分支机构则各自保留专属的本地仓储设施，以确保快速响应客户需求、具备灵活性，并可靠准时地交付产品。

秉承我们70年来作为一家值得信赖和享有盛誉的公司的传统，我们立志成为全球首选合作伙伴:以最高的诚信、真诚和谦逊标准服务我们的客户。

KIAN HO GROUP PRESENCE 建和集团的地点

SINGAPORE

KHG currently has 3 locations in Singapore and several overseas subsidiaries in Malaysia, Indonesia, Vietnam, Thailand and China.

建和集团(“KHG”)目前在新加坡设有3个分行,并在马来西亚、印度尼西亚、越南、泰国和中国设有多个海外子公司。



Jurong



Ubi



Changi

MALAYSIA

Kian Ho Bearings (M) Sdn. Bhd. (“KHM”) is a wholly-owned subsidiary of RUH and was established in 1975 with its operations headquarters located in Kuala Lumpur. KHM has 4 locations from North to South of Malaysia, including Penang, Kuala Lumpur, Kluang and Johor Bahru to cater to various industries and retail requirements.

建和轴承(马)私人有限公司(“KHM”)是RUH的全资子公司,成立于1975年,运营总部位于吉隆坡。KHM在马来西亚设有四个分行,包括槟城、吉隆坡、居銮和新山,以满足不同行业和零售业的需求。



Kuala Lumpur



Penang



Kluang



Johor Bahru

INDONESIA

PT. Kian Ho Indonesia is a 95%-owned subsidiary of RUH and was established in 2008 with its operations headquarters located in Jakarta and another branch located in Batam.

建和印尼私人有限公司是RUH拥有95%股权的子公司，成立于2008年，其运营总部位于雅加达，另一个分行位于巴淡岛。



VIETNAM

Kian Ho (Vietnam) Co., Ltd. is a wholly-owned subsidiary of RUH and was established in 2009 with its operations headquarters located in Ho Chi Minh city in South Vietnam and a branch located in Bac Ninh city in North Vietnam.

建和(越南)有限公司是RUH的全资子公司，成立于2009年，总部位于南越胡志明市，并在北越北宁市设有分行。



THAILAND

United Automation Co., Ltd. is a subsidiary of RUH and was established in 2024 located in Bangkok to serve end user requirements.

联合自动化有限公司是RUH的子公司，成立于2024年，位于曼谷，致力于满足最终用户的需求。



CHINA

Acker Machinery (Shanghai) Co., Ltd. is a wholly-owned subsidiary of RUH and was established in 1994 with its operations headquarters located in Shanghai city and sales representatives located in other cities in China and Hong Kong.

艾柯机械(上海)有限公司是RUH的全资子公司，成立于1994年，总部位于上海市，在中国其他城市和香港设有销售人员。



INDUSTRIES WE SERVE

Kian Ho's strength lies in the universal application of its Linear Motion Guides, Bearings, Seals, Electric Heaters, Shafts and Pneumatic products.

With a comprehensive portfolio of over 35,000 product types, our solutions are trusted across a wide spectrum of industries, including semiconductor and electronics, hard disk drive, robotics and automation, pharmaceutical and bio-medical, machine tools, food and beverage, construction and engineering, marine, petrochemical and oil and gas, automotive, transportation and ports, mining and agriculture.

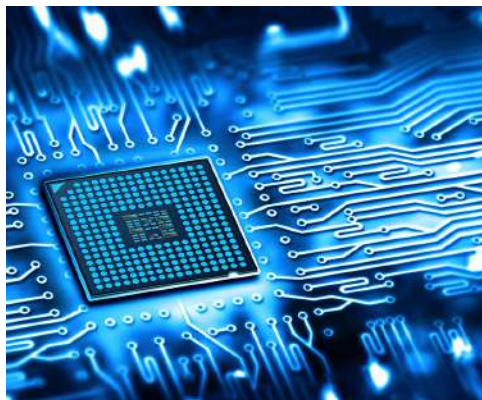

Semiconductor
半导体



Petrochemical
石油化工



Machine Tools
机床



Robotics
机器人技术



Construction
建筑



Automotive
汽车



Engineering
工程



Port
港口



Mining
矿业

我们服务的行业

建和的优势在于其直线运动系列、轴承、密封件、加热器和气动产品的通用性。

建和集团拥有超过35,000种直线运动系列、轴承、密封件、电加热器和气动产品，几乎应用于所有行业和产品，例如半导体和电子、硬盘驱动器、机器人和自动化、制药和生物医学、机床、食品和饮料、建筑和工程、船舶、石化和石油天然气、汽车、交通运输和港口、采矿和农业等行业。



Bio-Medical
生物医学



Hard Disk Drive
硬盘驱动器



Food & Beverage
食品和饮料



Pharmaceutical
制药



Transportation
运输



Automation
自动化



Electronics
电子产品



Marine
船舶工业



Agriculture
农业



NEEDLE ROLLER BEARINGS, CAM FOLLOWERS & SPHERICAL PLAIN BEARINGS

Nippon Thompson Co., Ltd., the maker of IKO brand, has an excellent track record in its quality and has a variety of its products as one of the world leading manufacturers of Needle Roller Bearings. It was the first company in Japan to launch technological development of Needle Roller Bearings and complete them as a machine element indispensable to the industry.

Needle Roller Bearings are bearings for rotary motion, in which needle-shaped thin rollers are incorporated instead of ball or other rolling elements. Needle Roller Bearings are smaller and lighter than ball bearings and cylindrical roller bearings, yet they have higher capacity loads. Thus, this helps to minimize the size of machinery, with cost-savings on energy consumption. Applications on an extreme range which spans from transportation vehicles to industrial machinery, machine tools, industrial robots, electric appliances and medical equipment. IKO also manufactures other machinery components such as Cam Followers/Roller Followers, Plain Spherical Bearings, and Cross Roller Bearings in variety to cater for a wide range of needs.





针形滚针轴承、凸轮滚针轴承 及球形平面轴承(关节轴承)

日本东晟株式会社(Nippon Thompson Co., Ltd.), IKO 商标的制造者, 无论从其产品的品质或种类, 都拥有作为世界领先的针形滚针轴承生产商的卓越记录。该公司是日本第一家开发针形滚针轴承科技, 并使该系列产品成为工业不可或缺的机械元件的企业。

针形滚针轴承是用于旋转运动的轴承, 由针形小滚针组合而成, 并非由滚球或其他滚动元件组成。针形滚针轴承的体积和重量比球轴承及圆柱滚针轴承都小, 但却能承受更高的满载负荷。因此, 有利于缩减机械尺寸, 及节省使用能源的开销。它们的极限应用范围很广, 包括交通工具、工业机械、工作母机、工业机器人、电器及医疗设备。

IKO 品牌也包括制造其他机械元件、例如各种各样的凸轮滚针轴承/滚轮滚针轴承, 平面球形轴承(关节轴承)以及交叉滚柱轴承, 以满足多种不同需要。





LINEAR MOTION PRODUCTS

Linear motion products are used in a wide variety of fields such as industrial robots, machine tools, office automation, factory automation, semi-conductor manufacturing equipment, medical equipment, etc. Various sizes for both ball and roller models are available for selection depending on customers' design and application. Advantages of such products include high positioning accuracy, reliability, flexibility in design, lower costs and reductions in machine size.





直线导轨系列

直线导轨系列用于多个领域，例如工业机器人、机床、办公自动化、工厂自动化、半导体生产设备、以及医疗设备等等。有多种不同尺寸的滚珠和滚子型号系，可供客户根据不同的设计和应用需要作出选择。产品的优势包括高定位精确度、可靠性、设计灵活性、低成本以及缩小机器体积。

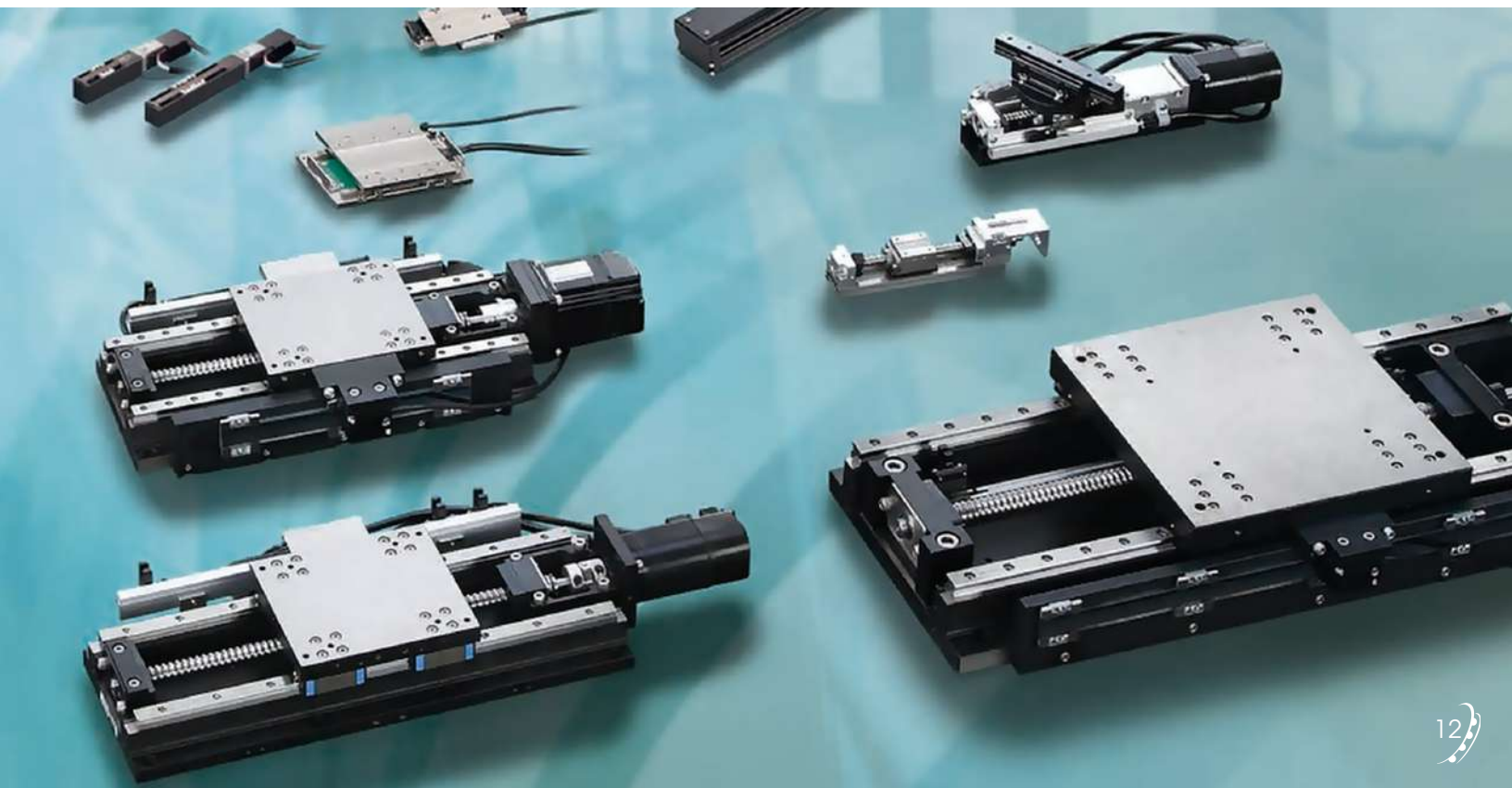



EZO bearings are used for various specifications for diverse industrial fields, including robotics and other leading-edge industries, in small lots of diverse products. Products include extra miniature/miniature/small bearings, flanged bearings, extra-thin-section bearings and large stainless-steel bearings designed to meet extensive and varied requirements.

EZO 轴承适用于各种规格，广泛应用于机器人等尖端工业领域，尤其适用于小批量、多样化的产品。产品包括超微型/微型/小型轴承、法兰轴承、超薄截面轴承以及大型不锈钢轴承，旨在满足各种不同的应用需求。

SOPHISTICATED HIGH-PRECISION PROCESSING TECHNOLOGIES

In manufacturing precision bearings, it's essential to have high-precision processors and to build up prominent technologies and gain the experience of using those processors. With precision processing technology that takes advantage of such comprehensive, long-established strengths, EZO has realized the manufacture of high-precision, quality products even for extra-thin-section and stainless-steel bearings, which require especially high-standard technology. Precise surface roughness processing of 10 nm (0.01 μm) is possible by the superfinishing of the raceway.

精密的高精度加工技术

在精密轴承制造中，拥有高精度处理器至关重要，并且需要建立卓越的技术体系，积累使用这些处理器的经验。凭借利用这些综合且长期积累的优势的精密加工技术，EZO 实现了高精度、高质量产品的制造，即使是超薄截面和不锈钢轴承，这些产品也需要特别高标准的技术。通过滚道超精加工，可以实现10纳米(0.01 微米)的精确表面粗糙度加工。



PRODUCTS THAT MEET A WIDE RANGE OF SPECIFICATIONS

Using bearing steel and highly corrosion-resistant stainless steel, bearings of various sizes can be produced, from extra-miniature to large. EZO also produces ultra-precision bearings, such as JIS Class 4 bearings, as well as products that meet various specification requirements by allowing for selection from among open, sealed or shielded bearings and different lubricants and radial internal clearances.

符合多种规格的产品

EZO 采用轴承钢和高耐腐蚀不锈钢，可生产各种尺寸的轴承，从超微型到大型。EZO 还生产超精密轴承，例如 JIS4 级轴承，以及满足各种规格要求的产品，客户可选择开放式，密封式或防尘式轴承，并可选择不同的润滑剂和径向内部间隙。

DEMAND FORECAST BASED ON AN ANALYSIS OF CUSTOMER NEEDS AND MANY YEARS OF EXPERIENCE

EZO determines demand trends by analysing customer needs accumulated over the course of many years. Lead time is minimized by proceeding with the production of semi-finished products based on appropriate demand forecast and by starting the assembly process depending on the specifications of individual customers (e.g., lubricant filling, seal/shield attachment) as soon as orders come in.

根据客户需求与多年累积下来的经验分析并预测需求量

EZO 通过分析多年来积累的客户需求来确定需求趋势。根据适当的需求预测，EZO 开始生产半成品，并在接到订单后立即根据各个客户的具体要求(例如、润滑油填充、密封件/护罩安装)启动组装流程，从而最大限度地缩短交货周期。

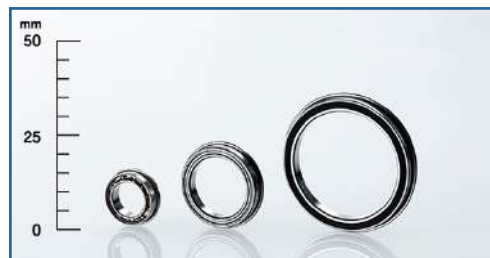

Extra-thin-section bearings
超薄截面轴承



Thrust bearings
推力轴承











Other (special products)
其他(特殊产品)



Founded in 1916, NSK is the first company in Japan to produce Japanese-made ball bearings. Through many years of experience and technology know-how, NSK products are widely used in many diversified industries like automotive, precision machinery and mechatronic industry.

The product range includes: Ball bearings, Cylindrical Roller bearings, Mounted units, Split housings, Needle bearings, Rolling Mill bearings, Super Precision bearings, Spherical Roller bearings, Tapered Roller bearings, Thrust bearings, etc.

Super Precision Bearings are widely used in modern machinery tooling systems to obtain high accuracy and high speed machining capabilities. These bearings are also commonly known as spindle bearings and are the most critical elements required in a machine tool. Other applications that require such precision bearings are in medical machines, textile machines, vacuum pumps, measuring instruments, machine tools, etc.

<p>Deep Groove Ball Bearings 深沟球轴承</p> 	<p>Angular Contact Ball Bearings 角接触轴承</p> 
<p>Single-Row Deep Groove Ball Bearings 单列深沟球轴承</p> 	<p>Single-Row Angular Contact Ball Bearings 单列角接触轴承</p> 
<p>Extra Small Ball Bearings and Miniature Ball Bearings 超小微型球轴承</p> 	<p>Matched Angular Contact Ball Bearings 配对角接触轴承</p> 
<p>Maximum Ball Bearings 满珠型轴承</p> 	<p>Double-Row Angular Contact Ball Bearings 双列角接触轴承</p> 
<p>Magneto Bearings 磁电机轴承</p> 	<p>Four-Point Contact Ball Bearings 四点接触球轴承</p> 



Super Precision Angular Contact Ball Bearings
调心滚子轴承



Cylindrical Roller Bearings
圆锥滚子轴承



Standard Series High-Precision Angular Contact Ball Bearings

标准高精度角接触轴承

NSKROBUST™ Ultra-High-Speed Angular Contact Ball Bearings

高速角接触球轴承ROBUST系列

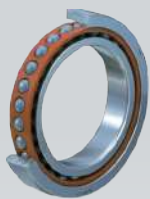

EW: Pressed Steel Cages
铁保持架

EM: Machined Brass Cages

铁保持架



NSKROBUST Spinshot™ II Ultra-High-Speed Angular Contact Ball Bearings with Oil-Air Lubrication

高速角接触球油气润滑轴承 ROBUST系列



ET: Polyamide Resin Cages
铜保持架

NSKROBUST™ BSR Series Ultra-High-Precision Angular Contact Ball Bearings

高速角接触球轴承ROBUST BSR系列



Hub Bearings
汽车轴承单元



日本精工株式会社(NSK)成立于1916年,是日本国内第一家设计生产轴承的厂商。几十年来,NSK开发出无数新型轴承,满足世界各地用户的需求,并为产业发展和技术进步做出了极大的贡献。同时NSK凭借其在精密加工方面的技术优势,不断开发汽车零部件、精密机械组件等高、精、尖产品,在电子应用等领域积极开展多元化经营。

NSK的主要产品是轴承,它是所有机器的基础;是现代生活中不可缺少的产品;素有“机械产业的粮食”之美称;它确保所有工业产品的质量;NSK的宗旨在于运行与控制;对机器的运转/摩擦现象寻根究底,以确保旋转和运作的平稳;它无时无刻不在,时刻为人类提供着丰富多彩的生活并将对全球性的节能运动和环境保护作出贡献。

超精密轴承广泛应用于现代机床系统中,以实现高精度和高速加工。这些轴承也常被称为主轴轴承,是机床中最关键的部件。其他需要此类精密轴承的应用领域包括医疗器械、纺织机械、真空泵、测量仪器、机床等。

With more than a century of expertise in world-class precision technology, equipment manufacturers place their trust in KURODA JENATEC.

KURODA JENATEC's foundation in precision manufacturing and precision measurement has been the cornerstone of global success as a leading supplier of linear motion components for the semiconductor, medical device, automation, and pharmaceutical industries.

Under the KURODA JENATEC brand, KURODA JENATEC global network delivers a wide range of products including ball screws, ball screw actuators, and other linear motion components ready to meet the ever-changing demands of today's markets.

BALL SCREWS

Shaft Diameters 6mm-125mm Accuracy Grades C1-C10

滚珠丝杠:
滚珠丝杠轴径6mm-125mm精度



D-Series

Accuracy Grades C1, C3

D 系列
精度等级 C1、C3

Ultra precision
Industry's most compact nut
Ideal for fine lead positioning

超高精度, 业界最紧凑的螺母, 是精细导程定位的理想之选。



A-Series

Accuracy Grades C5, C7

A 系列
精度等级 C5、C7

Ultra quiet slim nut
Built-in lubrication unit

超静音超薄螺母, 内置润滑装置。



F-Series

Accuracy Grades C5, C7

F 系列
精度等级 C5、C7

High speed end-deflector type
Lower Sound Pressure
Compact nut length

高速端部导流型, 降低声压, 螺母长度紧凑。



G-Series

Accuracy Grades C3, C10

G 系列
精度等级 C3、C10

Wide variety diameters and leads
Standard offerings for both positioning and transfer applications.

多种直径和引线规格, 标准产品适用于定位和传输应用



H-Series

Accuracy Grades C5

H 系列
精度等级 C5

Ultra high-speed
Multi-starts at high leads
High load capacity yet compact

超高速多点启动, 高负载能力, 结构紧凑。



P-Series

Lead Screws

P 系列
导螺杆

Lightweight
Corrosion-resistant resin nut

轻质耐腐蚀树脂螺母。





凭借一个多世纪以来在世界一流精密技术领域的专业经验，设备制造商信赖黑田精工 (KURODA JENATEC)。黑田精工在精密制造和精密测量领域的深厚根基，是黑田精工作为半导体、医疗设备、自动化和制药行业领先的直线运动部件供应商取得成功的基石。

在黑田精工品牌下，黑田精工的全球网络提供包括滚珠丝杠、滚珠丝杠执行器和其他直线运动部件在内的各种产品，以满足当今市场不断变化的需求。

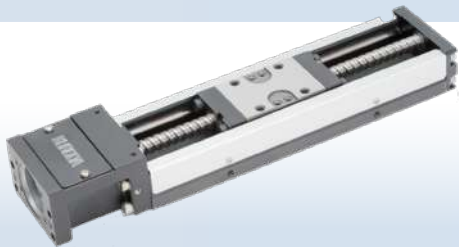

SE-Series

Maximized Performance and Value

SE系列

性能与价值最大化

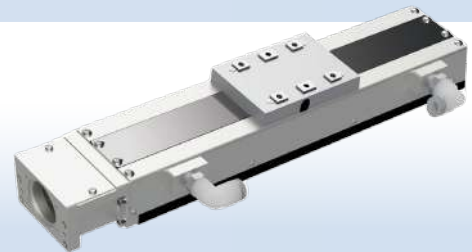

Bidirectional Actuators

Open/close gripping motion achieved

with single unit

双向执行器

单单元即可实现开/闭夹动作



SE-Series

High Precision Type

SE系列

高精度型



SC-Series

Full Cover Type

Performance Comparable to SE Series

SC系列

全覆盖式

性能与SE系列相当

DRY BEARINGS

Dry Bearings offer low coefficients of static and dynamic friction, good strength and dimensional tolerance. They are also tolerant to most chemicals and solvents making them suitable for a variety of industries, including transportation, machineries, construction, agriculture, and hydraulic systems. These bearings require little to no lubrication, thus usage of these bearings entails easy maintenance and reliable long-term performance.

乾式轴承(完全无给油轴承)

乾式轴承具有低静摩擦系数和动摩擦系数、良好的强度和尺寸精度。乾式轴承也能耐受大多数化学品和溶剂,这使它们适合用于多种工业,例如交通,机械,建筑,农业,液压系统等等。由于这些轴承只需要少量润滑剂甚至无需润滑剂,因此简化了使用这些轴承的保养工作。

CONTAMINATION RESISTANT 抗污染



BUSHING
衬套



THERMALLOY
T type
热合金T型



THERMALLOY
BB type
热合金BB型



THERMALLOY
pillow unit
热合金枕式轴承



DAIBEST
DBX01
金属衬套



THERMALLOY
PV plates
热合金光伏板

VIBRATION RESISTANT 抗震



DAIBEST DBB01



DAIBEST DBX01



DAITHERMO DTK



DAIHYLON DHR

APPLICATIONS 应用领域



Food & Ecology 食品与生态



Transport 运输



Construction 建筑



General Industry 通用工业



Amusement 娱乐



Leisure & Sport 休闲与运动



Founded in 1923, SAKAGUCHI has been delivering tailored heating solutions to a wide range of industries. With over a century of expertise, SAKAGUCHI has grown in product capability and market experience, providing customers with superior products and services for individual needs.

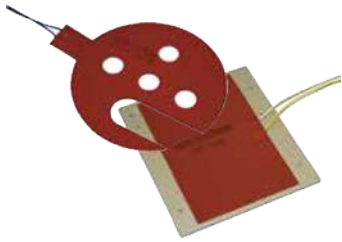

Silicon Rubber Heaters
"Samicon 230"
硅橡胶加热器
"Samicon 230"



Silicon Rubber Heaters
"Samicon Super 340II"
硅橡胶加热器
"Samicon Super 340II"



High-temperature Silicon
Rubber Heaters
"Samicon 420"
高温硅橡胶加热器
"Samicon 420"

1. Heaters for flat and tubular form heating

Highly flexible material is used to enable construction and heating in close contact with the heated part.

2. Heaters for liquid and gas heating

These sheath heaters are produced in various shapes, such as straight, U-shaped and M-shaped. They are used for heating of water, gases, chemicals, etc.



"EMIFLON" Heaters for
Heating Chemicals
用于 "EMIFLON"
加热器的加热化学品



Immersion Tubular
Heaters
浸入式管
加热器



Stainless Steel
Tubular Heaters
不锈钢
管式加热器



Micro Cable
Air Heaters
微型电缆
空气加热器



Non-flame Air Heaters
无焰空气加热器



Quartz Far
Infrared Heaters
石英远
红外线加热器

3. Gas and infrared heaters

These heaters heat objects without coming into direct contact with them.

坂口创立于1923年，一直致力于为各行各业提供量身定制的供暖解决方案。凭借一个多世纪的专业经验，SAKAGUCHI 在产品能力和市场经验方面不断成长，为客户提供满足其个性化需求的卓越产品和服务。

4. Heaters for mold heating and injection molding

Select according to the shape of the object you want to heat, such as mold or injection molding machine nozzle.



Band Heaters
带式加热器



Strip Heaters
带状加热器



Cable Heaters
电缆加热器



Micro Ceramic Heater
“MS-1000R”
微型陶瓷加热器
“MS-1000R”



Micro Ceramic Heater
“MC1010H”
微型陶瓷加热器
“MC1010H”

5. Compact high-output ceramic heaters / Other custom products, etc

In addition to ceramic heaters as small as 10 mm², capable of operating at temperatures up to 1000°C, SAKAGUCHI offers customizable solutions including hot plates for semiconductor and LCD heating processes, as well as pre-heaters and duct heaters for manufacturing equipment. All products can be tailored to meet your specific requirements.

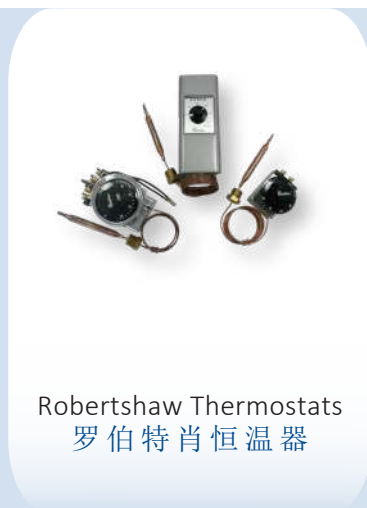

Robertshaw Thermostats
罗伯特肖恒温器



Heat Resistant
Leadwires LKGB
耐热导线 LKGB

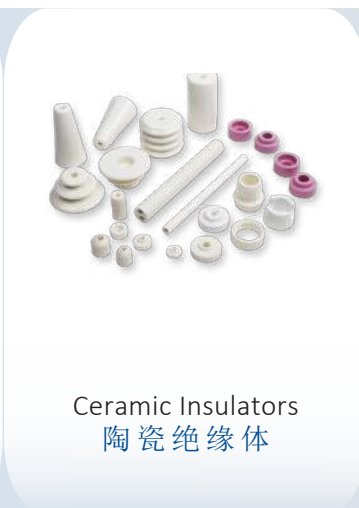

Ceramic Insulators
陶瓷绝缘体



EXLASER
激光器

AirTAC

Established in 1988 and headquartered in Taiwan, AirTAC International Group is a globally recognized supplier and manufacturer of transmission equipment. AirTAC is specialized in producing preparation units, control components, actuators and accessories which are widely applied in the automotive, machinery manufacturing, metallurgy, electronics, rail transit, environmental protection, lighting, textile, ceramics, medical equipment, food, packaging and automated industrial fields.

亞德客国际集团1988年在台湾成立并设立总部，是世界市场上知名的传动设备供应商与制造商。亞德客专注于生产预处理单元、控制元件、执行器及配件，产品广泛应用于汽车、机械制造、冶金、电子、轨道交通、环保、照明、纺织、陶瓷、医疗器械、食品、包装和自动化工业等领域。



CONTROL COMPONENTS 控制元件

- Solenoid Valve 电磁阀
- Air valve 空气阀
- Manual control valve 手动控制阀
- Mechanical control valve 机械控制阀
- Fluid control valve 流体控制阀
- Other valves 其他阀门

PREPARATION UNIT 准备单位

- GA Series GA系列
- A,B Series A,B系列
- Others 其他系列



ACCESSORIES 配件



- Polyurethane tubing 聚氨酯管
- Fitting, Silencer 配件, 消音器
- Speed Controller 速度控制器
- Finger valve 指阀器
- Stainless steel fitting 不锈钢配件
- Stainless steel silencer 不锈钢消音器
- Stainless steel controller 不锈钢控制器
- Pneumatic indicator 气动指示器

WON

WON SHAFT

万思特

Established in 1989, WonST Co., Ltd is pioneering global markets through proprietary technologies and innovative solutions with variety of products including shafts. WonST holds technological prowess, innovation, customer-oriented attitude, collaborative mindset, and self-directed work performance as its core values.

万思特有限公司成立于1989年，凭借其专有技术和创新解决方案，以及包括轴在内的多种产品，在全球市场占据领先地位。万思特秉持技术实力、创新精神、客户至上、协作精神和自主工作作风的核心价值观。



WON

주식회사 원

CORE TECHNOLOGIES 核心技术



Precision grinding technology
精密研磨技术



Rolling motion based technology
基于滚动运动的技术



Heat treatment technology
热处理技术

PRODUCTS 产品



Solid Shaft
实心轴



Hollow Shaft
空心轴



Machining Shaft
加工轴



Linear Shaft Custom-made
定制线性轴



WS

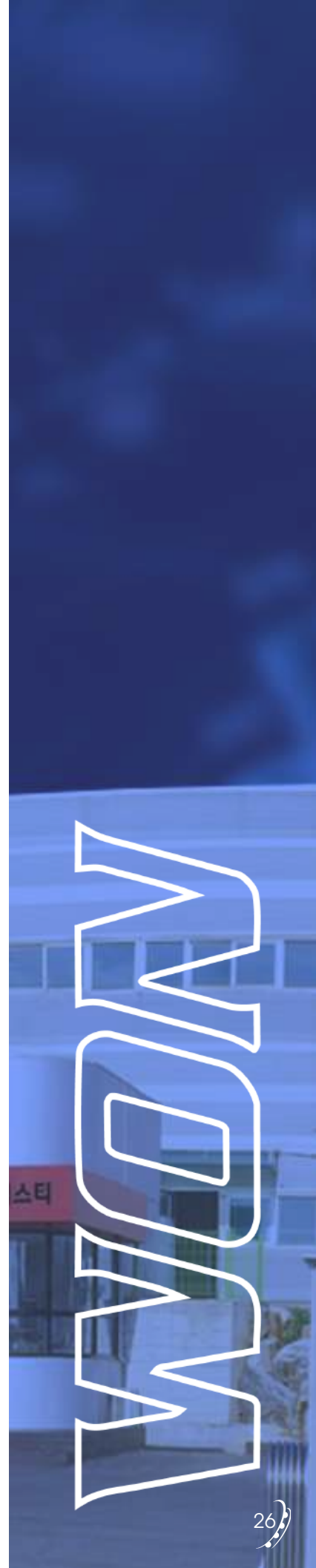

NTN

Founded in 1918 and headquartered in Osaka, NTN is one of the top three bearing manufacturers in Japan (alongside NSK and JTEKT/Koyo). Its core products include ball bearings, roller bearings and specialized bearings designed for high speed or heavy load applications.

NTN 成立于1918年，总部位于大阪，是日本三大轴承制造商之一(与NSK和JTEKT/Koyo并列)。其核心产品包括球轴承、滚子轴承以及专为高速或重载应用而设计的专用轴承。



Product Overview 产品概述

Ball Bearings 滚珠轴承

滚珠轴承



Deep Groove Ball Bearings
深沟球轴承



Angular Contact Ball Bearings
角接触球轴承



Insulated Ball Bearings
绝缘球轴承



Special Ball Bearings
特种滚珠承

Cylindrical Roller Bearings 圆柱滚子轴承

圆柱滚子轴承



Cylindrical Roller Bearings
圆柱滚子轴承



Insulated Cylindrical Roller Bearings
绝缘圆柱滚子轴承



Differential Kits
差速器套件



Flanged Disc Units
法兰式盘片单元

Applications 应用领域



Automobile 汽车



Construction machinery
工程机械



Wind turbine 风力涡轮机



Also provides **the world's smallest size*** with an inner diameter of 0.6 mm!

Electronic device 电子设备

Contribute to safety operation at speed of **300 km/h**



Rolling stock 机车车辆

Maintain high precision at high temperatures of **200 °C**



Aircraft 飞机



Since 2001, UBC Precision Bearing Manufacturing Company, a wholly owned subsidiary of Nippon Thompson Co., Ltd, has been producing high-quality standard bearings for both OEMs and aftermarket, as well as custom-engineered bearings for specialized applications. Renowned for reliable quality, professional service and competitive pricing, UBC products offer an ideal solution for customers seeking to reduce costs without compromising bearing performance.

UBC 精密轴承制造公司,日本东晟株式会社全资子公司,自2001年以来,一直致力于为售后市场和 OEM 厂商生产标准轴承,并为特殊应用定制设计轴承。作为一家值得信赖的品牌,UBC 产品以可靠的质量、专业的服务和具有竞争力的价格而闻名,是那些希望在不牺牲轴承性能的前提下降低成本的客户的理想选择。



GP manufactures adaptor sleeves, withdrawal sleeves, lock nuts and washers. Adaptor sleeves are used for fastening bearings with a tapered bore to cylindrical shafts. The adaptor sleeves allow for the shafts to be machined to a larger diameter tolerance than if the bearing is sitting on the shaft itself. Withdrawal sleeves are used to mount bearings with tapered bore on cylinder shaft. The bearing rests against a shaft shoulder; the tapered sleeve is pressed into bearing bore until the radial clearance is reduced to the required amount.

紧固退卸套连接套的作用是将带有圆锥孔的轴承与圆柱轴固紧。与将轴承置于轴身之上的装置相比,使用连接套让轴可以在机械上加工,达到较大的直径公差。退卸套的作用是将带有圆锥孔的轴承定位在圆柱轴上。轴承靠在一个轴肩上,圆锥退卸套则被压入轴承孔,直到径向间隙被缩小到要求尺寸为止。



Established in 1921, Koyo is now a bearing brand under JTEKT Corporation. Its main products include ball bearings, roller bearings, needle bearings, angular contact bearings, automotive bearings, and industrial bearings. Koyo is especially strong in the automotive, truck, and heavy machinery sectors.

Koyo 成立于1921年,现为捷太格特株式会社旗下的轴承品牌。其主要产品包括滚珠轴承、滚子轴承、滚针轴承、角接触轴承、汽车轴承和工业轴承。Koyo 在汽车、卡车和重型机械领域尤为强大。



BALL BEARING 滚珠轴承

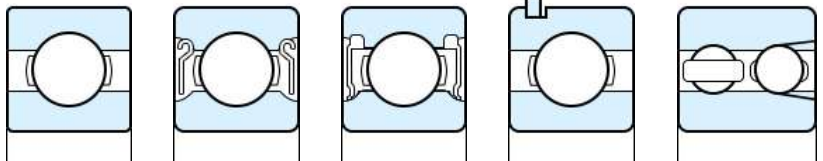

SPECIAL ENVIRONMENT BALL BEARINGS 特殊环境用球轴承



SELF-ALIGNING BALL BEARINGS 自调心球轴承

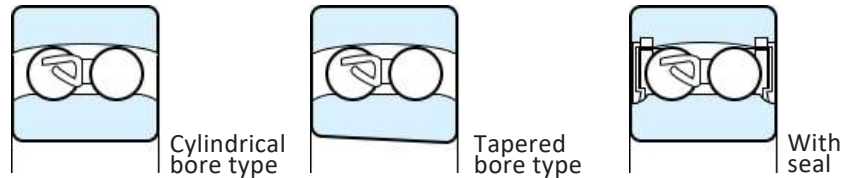

TAPERED ROLLER BEARING 圆锥滚子轴承

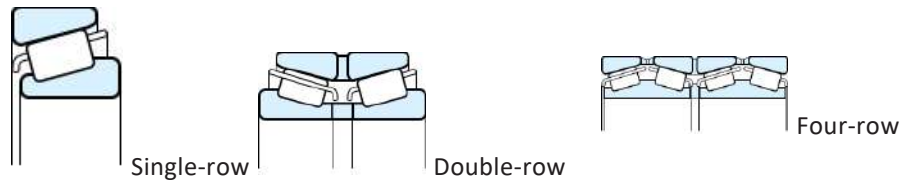



TECHNOLOGICAL INNOVATION 技术创新

HZF specializes in manufacturing 1st, 2nd and 3rd generation wheel hub assemblies, along with a diverse range of over 2,900 precision bearing types. HZF products are widely used in mid- to high-end sedans, commercial vehicles and trucks, and are trusted by customers in more than 30 countries worldwide.

兆丰专注于生产第一代、第二代和第三代轮毂轴承,以及超过2,900种精密轴承。兆丰产品广泛应用于中高端轿车、商用车和卡车,深受全球30多个国家客户的信赖。

First generation hub bearing unit

第一代轮毂轴承单元



Second generation hub bearing unit

第二代轮毂轴承单元



Third generation hub bearing unit

第三代轮毂轴承单元



Single Row tapered roller bearing

单列圆锥滚子轴承



TESTING AND INSPECTION 测试与检验

HZF is equipped with comprehensive testing and inspection facilities, including bearing life testers, friction and torsion testers, brine and mud simulation machines, impact simulation devices, radial-torsional testers, and more. Its precision measurement capabilities extend to length measurement systems, roundness and profile instruments, taper gauges, and over 400 additional tools, ensuring complete control from design through production. All components undergo 100% inspection during manufacturing, guaranteeing the highest standards of quality and reliability.

HZF's robust quality management system and extensive testing expertise have enabled the company to achieve numerous certifications, including ISO 9002, QS 9000, TUV's ISO 9001 since 2006, and ISO/TS 16949. These accolades reflect HZF's commitment to delivering superior quality products and exceptional service to its customers.

兆丰集团配备了完善的测试和检测设备,包括轴承寿命试验机、摩擦和扭转试验机、盐水和泥浆模拟试验机、冲击模拟装置、径向扭转试验机等。其精密测量能力涵盖长度测量系统、圆度和轮廓测量仪、锥度规以及400多种其他测量工具,确保从设计到生产的全程控制。所有零部件在生产过程中均经过100%检验,保证了最高的质量和可靠性标准。

兆丰凭借其完善的质量管理体系和广泛的测试技术,获得了多项认证,包括ISO9002、QS 9000、自2006年起获得TUV的ISO9001认证以ISO/TS16949认证。这些荣誉体现了HZF致力于为客户提供优质产品和卓越服务的承诺。





INA / FAG BEARINGS

The Schaeffler Group is a global leader in automotive and industrial manufacturing, offering a comprehensive range of needle roller bearings, ball bearings, plain ball bearings, cylindrical bearings, and more. Through its brands, INA and FAG, Schaeffler delivers high-precision components and systems for engines, transmissions, and chassis, as well as rolling and plain bearing solutions for diverse industrial applications. By combining innovation with engineering excellence, the Group makes a decisive contribution to mobility and industrial advancement worldwide.

舍弗勒集团是一家全球领先的汽车和工业供应商。舍弗勒集团凭借其在发动机、变速器和底盘应用领域的高精度零部件和系统，以及面向众多工业应用的滚动轴承和滑动轴承解决方案，为移动出行领域做出了卓越贡献。自成立以来，舍弗勒公司始终秉承突破性创新和全球客户导向的理念。



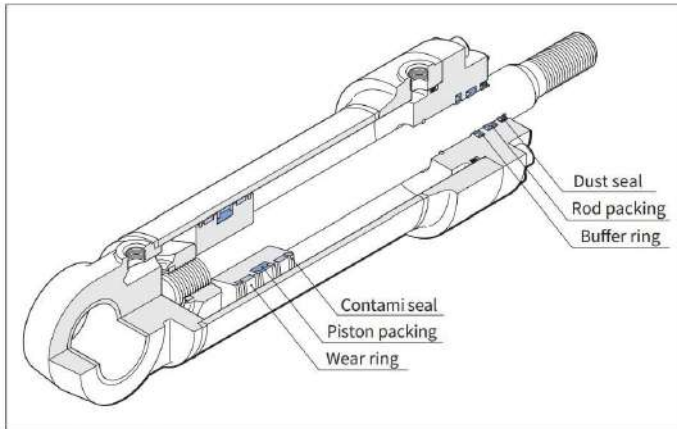

Application example for hydraulic cylinder
 液压缸应用实例

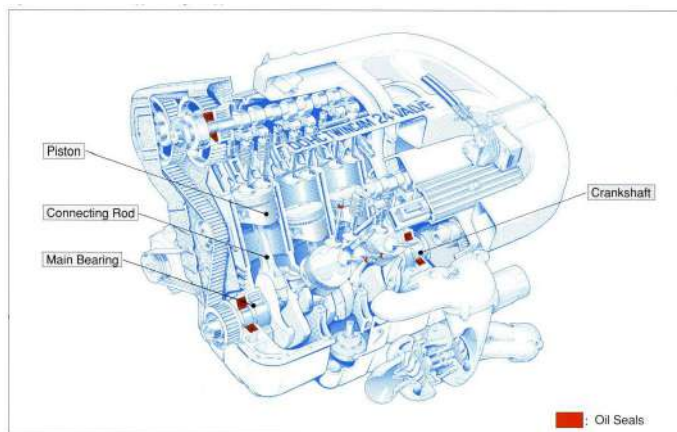

Oil Seals in a Typical Engine Application
 典型发动机应用中的油封

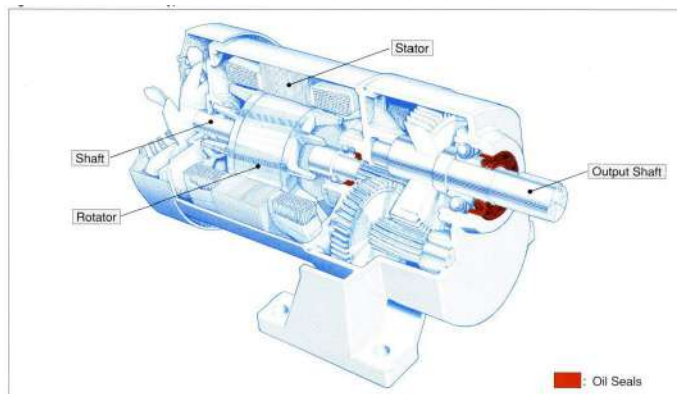

Oil Seals used in a Typical Geared Motor
 典型齿轮电机中使用的油封



Oil Seals:

A rotary oil seal is one of the machine elements used to prevent oil leakages from the rotary shaft and housing clearance. Various types of synthetic rubber materials and seal designs are available to suit a wide range of applications.

油封：

旋转油封是用于防止旋转轴与壳体间隙处漏油的机械元件之一。有多种合成橡胶材料和密封设计可供选择，以满足各种应用需求。



Hydraulic Packings:

A sealing element of hydraulic or pneumatic system. Various types of synthetic rubber materials and seal designs are available to suit a wide range hydraulic/pneumatic cylinders on static or dynamic application.

液压密封件：

液压或气动系统的密封元件。多种合成橡胶材料和密封设计可供选择，适用于各种静态或动态应用的液压/气动缸。



Oil seal

Provides both sealing and lubrication for motion surfaces such as machine rotary shafts.

油封

可为机器旋转轴等运动表面提供密封和润滑。



Hydraulic packings

Offers both sealing and lubrication for reciprocating surfaces using a variety of materials, from rubber to resin.

液压密封件

采用橡胶、树脂等多种材料,为往复运动表面提供密封和润滑双重功能。



O-ring

Annular rubber seal utilizes compression-generated repulsive force for secure sealing.

O型圈

环形橡胶密封件利用压缩产生的斥力实现牢固密封。



Low-friction technology

Low-friction seal products utilizing NOK's advanced technology.

低摩擦技术

采用 NOK 先进技术的低摩擦密封产品。



Sleeved oil seal

Integrated seal and sleeve structure prevents the intrusion of muddy water, sand, and dust.

套筒式油封

密封圈和套筒一体化结构可防止泥水、沙粒和灰尘的侵入。



High-speed rotary oil seal

Balances sealing performance and low torque during high-speed main rotation and reverse rotation.

高速旋转油封

在高速正反转过程中,兼顾密封性能和低扭矩。



Low-friction oil seal

Reduces friction by up to 70% while maintaining sealing performance.

低摩擦油封

在保持密封性能的同时，降低摩擦高达70%。



Contamination-resistant oil seal

Proprietary lip design prevents metal wear particles from entering the unit, enhancing durability.

抗污染油封

独特的唇形设计可防止金属磨损颗粒进入装置内部，从而提高耐用性。



Dust-resistant oil seal

Prevents sand and dust intrusion with a unique design.

防尘油封

采用独特设计，防止沙尘侵入。



Conductive ring

Uses proprietary materials to reduce electromagnetic noise and prevent galvanic corrosion, enabling space savings.

导电环

采用专有材料降低电磁噪声并防止电偶腐蚀，从而节省空间。



Flame retardant O-ring

Made from flame-retardant EPDM material that meets UL94 V-0 (flammability rating standard).

阻燃O型圈

采用符合UL94 V-0(阻燃等级标准)的阻燃EPDM材料制成。



Hydrogen-resistant O-ring

Maintains long-term sealing even in extreme-low temperatures below -50°C.

耐氢O型圈

即使在低于-50°C的极低温下也能保持长期密封性能。

Hallite gives you complete confidence in the performance of your hydraulic cylinders, producing premium seals, wipers and bearings of proven quality, and delivering them across the world.

Hallite 为您提供液压缸性能方面的完全信心，生产品质卓越的密封件、刮油器和耐磨环，并销往世界各地。

Rod Seals

Profile	Hallite type
	15
	16
	18
	21
	513
	601
	605
	610
	616
	621
	631
	652
	653

Piston Seals - Double Acting

Profile	Hallite type
	50
	51
	52
	53
	54
	56
	58
	64
	65
	68
	77

Piston Seals - Double Acting

Profile	Hallite type
	735
	753
	754
	755
	770

Piston Seals - Single Acting

Profile	Hallite type
	66
	71
	511
	512
	601
	606
	659

Vee pack sets

Profile	Hallite type
	07
	09
	11
	12
	13
	14

Wipers

Profile	Hallite type
	33
	38

Wipers

Profile	Hallite type
	520
	831
	834
	839
	842
	846
	860
	862

Bearings

Profile	Hallite type
	87
	506
	533

Additional products

Profile	Hallite type
	80
	657

Rod Seals:



The rod seal is the most critical seal on any type of fluid power equipment preventing leakage of fluid from within the cylinder to the outside.

活塞杆密封件：

活塞杆密封件是任何类型的液压设备中最关键的密封件，它能防止液压油从气缸内部泄漏到外部。

Single Acting Piston Seals:



Piston seals or piston rings are used in hydraulic cylinders for fluid sealing and are designed to ensure that pressurised fluid does not leak across the cylinder head as the system pressure pushes the piston down the cylinder bore.

单作用活塞密封件：

活塞密封件或活塞环用于液压缸中，起到流体密封的作用，其设计目的是确保在系统压力推动活塞沿缸筒向下运动时，加压流体不会从缸盖泄漏。

Double Acting Piston Seals:

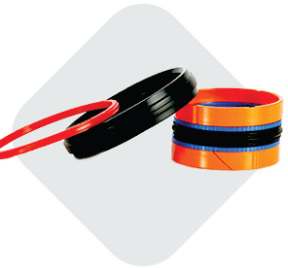

Piston seals or piston rings are used in hydraulic cylinder for fluid sealing and are designed to ensure that pressurised fluid does not leak across the piston as the system pressure pushes the piston down the cylinder bore.

双作用活塞密封件：

活塞密封或活塞环用于液压缸中，以实现流体密封，其设计目的是确保在系统压力推动活塞沿缸筒向下运动时，加压流体不会泄漏到活塞周围。

Wipers:



Wipers are installed in the sealing configurations of hydraulic cylinders to prevent contaminants such as dirt, dust and moisture from entering the cylinder as they retract back into the system.

防尘密封件：

防尘密封件安装在液压缸的密封结构中，以防止污垢、灰尘和湿气等污染物在液压缸缩回系统时进入缸内。

Rod Buffer Seals:



The primary purpose of the buffer seal is to protect the main rod seal from the effects of shock pressure loading.

连杆缓冲密封件：

缓冲密封件的主要作用是保护主连杆密封件免受冲击压力载荷的影响。

SAKAGAMI STANDARD PRODUCTS 阪上标准产品

SAKAGAMI HYDRAULIC AND PNEUMATIC SEALS 阪上液压气动密封件

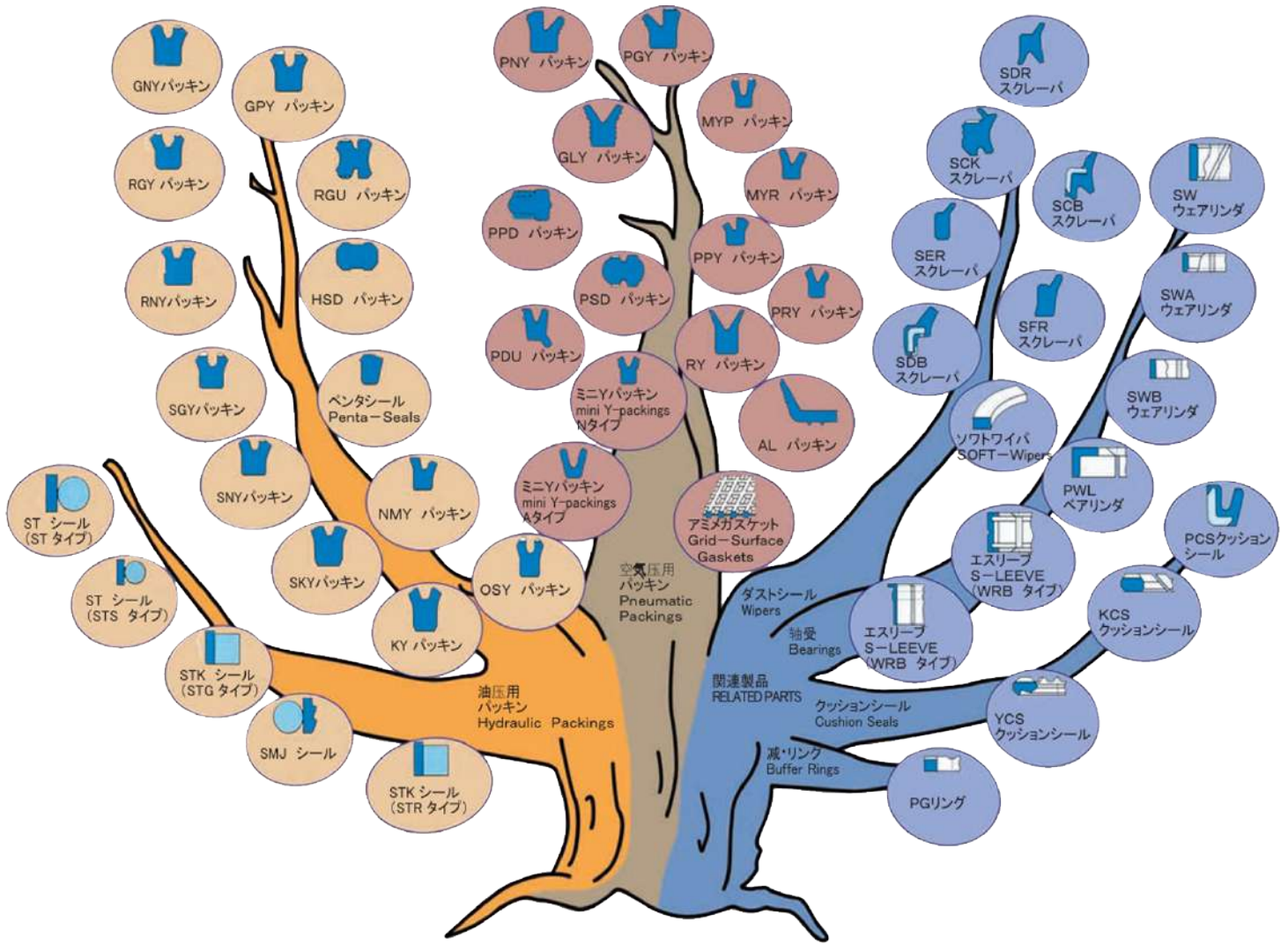

Pin, Dust & Wiper Seals
插销、尘埃和防尘密封环



Hydraulic Seals
液压密封



Pneumatic Seals
气动密封件

HYDRAULIC CYLINDER SEAL KITS 液壓缸油封組合

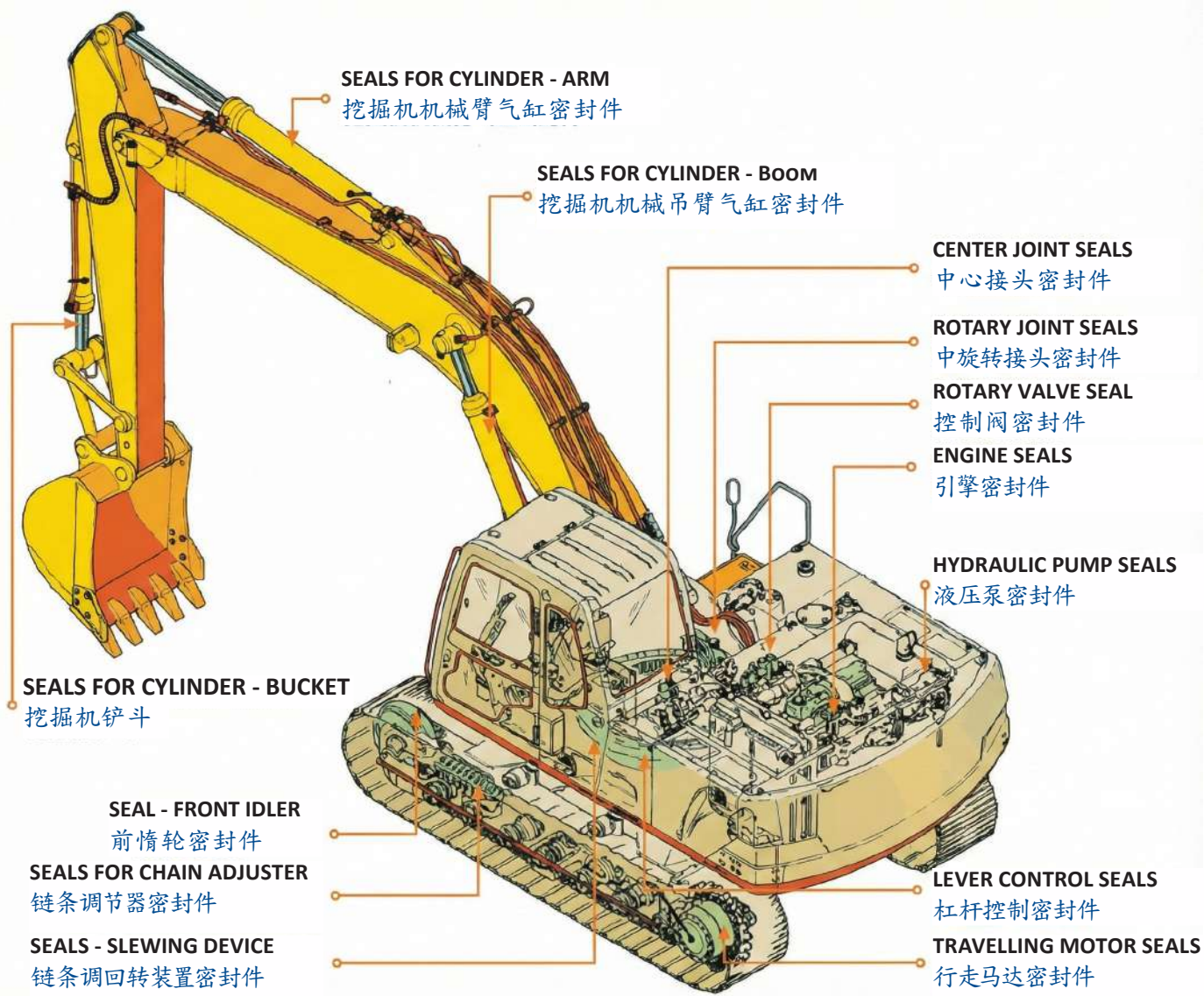

Cylinder Seal Kits for Construction Heavy Equipments

气缸密封套件用于建筑重型机械

Excavators, Crawler Loaders, Crawler Tractors, Skid Steer Loaders, Wheel Loaders, Swap Dozers, Hydraulic Hammers, Dump Trucks, Mobile Cranes, Lorry Mounted Cranes, Forklifts & etc

挖土机、堆高机、移动吊车、倾卸卡车、轮胎及各式装载机等



SEALS:



Oil Seals:

A rotary oil seal is one of the machine elements used to prevent oil leakages from the rotary shaft and housing clearance. Various types of synthetic rubber materials and seal designs are available to suit a wide range of applications.

油封:

旋转油封是用于防止旋转轴承箱间隙漏油机械元件之一。有多种合成橡胶材料和密封设计可供选择，适用范围很广泛。

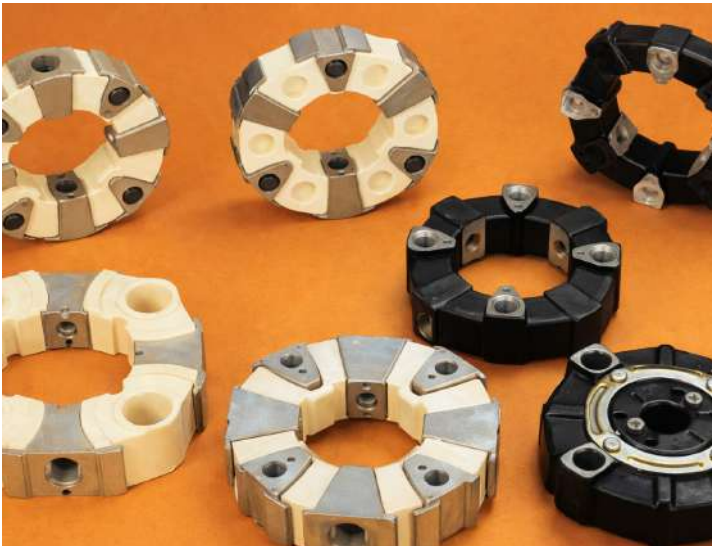

Pump Couplings:

For generator, pump driving of excavators.

泵接口:

浮式密封用于维持润滑油稳流和防止杂质渗透。



Mechanical Seals:

General purpose mechanical seals are widely used in the field of motor vehicles, home appliances, pumps and machineries.

机械密封:

机械密封普遍通用于机动车辆、家用电器、泵及机械领域。



Hydraulic Packings:

A sealing element for hydraulic or pneumatic system. Various types of synthetic rubber materials and seal designs are available to suit a wide range of hydraulic / pneumatic cylinders on static or dynamic application.

液压封垫：

液压封垫是一种用于液压系统或气动系统的密封元件。有多种类型的合成橡胶材料及密封设计可供选择，适合静态或动态应用的多种液压汽缸、气动汽缸。



Floating Seals:

Floating seals are used for the purpose of keeping up the steady flow of the lubricating oil and preventing the infiltration of impurities.

浮式密封：

浮式密封用于维持润滑油稳流和防止杂质渗透。



O Rings:

Seals of the simplest construction and easiest to apply. Made of various types of synthetic rubber materials, these seals offer a wide range of application.

O型环：

O型环是构造最简单而且最容易使用的密封圈。由多种类别的合成橡胶制成，这些密封圈的用途广泛。

PARKER - STANDARD PRODUCTS

Piston Seals	
Profile	Parker type
	OG
	OK
	PZ
	Z5
	Z7
	Z8
	ZA
	ZC
	ZD
	ZK
	ZP
	ZQ
	ZS
	ZW
	ZX
	ZY

Wipers	
Profile	Parker type
	A1
	A2
	A5
	A6
	AD
	AF
	AG
	AH
	AM
	AT
	AY

Guiding Elements	
Profile	Parker type
	F1
	F2
	F3
	FP
	FR

PTFE Back-up-rings	
Profile	Parker type
	XA
	XB
	XC

Flange Seals	
Profile	Parker type
	V2
	OV

PU-O-Ring	
Profile	Parker type
	V1

Cushioning Seals	
Profile	Parker type
	V6
	PP

Rotary Seals	
Profile	Parker type
	C1
	C5
	C9
	KA
	OR
	RS

Flexiseals [®]	
Profile	Parker type
	JD
	JR
	JS
	JK
	JF
	JG
	JB
	JC
	JE
	JH

Sealing systems for dual media

	KS
--	----

Seals for water pump	
Profile	Parker type
	W1
	W2/W3
	W7

PARKER - STANDARD PRODUCTS

Rod Seals	
Profile	Parker type
	B3
	BA
	BD
	BS
	BU
	C1
	C3
	CR
	E5
	E8
	E9 ²⁾
	EL
	EM
	EP
	EU ³⁾
	EV
	GC
	JA
	M0

Rod Seals	
Profile	Parker type
	M2
	M3
	M5
	OD
	ON
	Q3
	R3
	Z9
	ZE
	ZG
	ZH
	ZJ
	ZR
	ZU

Piston Seals	
Profile	Parker type
	B7
	C2
	CP
	D1
	DK
	DL ⁴⁾
	DP
	DE
	E4
	EK
	GD
	KR
	KU
	M4
	NG
	N0
	OA
	OE



KIAN HO GROUP

CORPORATE MILESTONES 企业里程碑

- 1956** Started operations as a sole proprietorship
以独资形式开始营业
- 1973** Converted from sole proprietorship to a private limited company
从独资变更为私人有限公司
Set up a wholly-owned subsidiary “Kian Ho Bearings (M) Sdn Bhd” in Malaysia
设立马来西亚子公司:建和轴承(马)私人有限公司
- 1975** Acquired authorised distributorship for IKO bearings from Japan
获得日本IKO 轴承的代理商授权
Acquired authorised distributorship for NOK seals from Japan
获得日本NOK密封件的代理商授权
Acquired authorised distributorship for Kuroda Precision ball screws from Japan
获得日本Kuroda 滚珠丝杠的代理商授权
- 1978** Set up new branch in Jurong, West Singapore
在新加坡西部裕廊设立分行
- 1980** Acquired authorised distributorship for HALLITE seals from UK
获得英国HALLITE 密封件的授权经销权
- 1988** Acquired authorised distributorship for DAIDO bearings from Japan and GP bearings from Taiwan
获得日本DAIDO及台湾GP轴承产品的授权经销权
- 1994** Established a wholly-owned subsidiary, Acker Machinery (Shanghai) Co., Ltd in Shanghai, China
在中国上海设立全资子公司:艾柯机械(上海)有限公司
Acquired authorised distributorship for EZO bearings from Japan for South East Asia
获得日本EZO 轴承东南亚的授权经销权
- 1995** Listed as a public limited company on SESDAQ
在新加坡SESDAQ 挂牌上市
- 1997** Upgraded to the Main-board of the Singapore Exchange Ltd (SGX)
晋升为新加坡股票交易所(Singapore Exchange Ltd, SGX)的主板上
市公司
- 1998** Construction of a new 5-storey building in Changi South Business Park, East Singapore
开始在新加坡东部樟宜南建造一栋五层楼的办公兼货仓大楼
- 2000** Shifted to new head office and warehouse in Changi South Business Park, East Singapore
总部迁至新加坡东部樟宜南
- 2006** Acquired authorised distributorship for Sakagami seals from Japan
获得日本 Sakagami 的代理商授权
- 2007** Acquired authorised distributorship for NSK bearings from Japan
获得日本 NSK 轴承产品的代理商授权
- 2008** Established a subsidiary, PT. Kian Ho Indonesia in Indonesia
在印尼设立全资子公司:建和印尼有限公司

- 2009** Established a wholly-owned subsidiary, Kian Ho (Vietnam) Co., Ltd in Vietnam
在越南设立全资子公司:建和越南有限公司
- 2014** The Holding Company, Kian Ho Bearings Ltd, was renamed as Raffles United Holdings Ltd, following a successful general offer by the present owner.
由于当前股东家族成功收购母公司股权成为大股东，母公司建和轴承有限公司改名为莱佛士联合控股有限公司
Established a wholly-owned subsidiary “Kian Ho Pte Ltd” in Singapore
新加坡设立全资子公司:建和私人有限公司
Transferred bearings and seals business of Raffles United Holdings Ltd to Kian Ho Pte Ltd
将莱佛士联合控股有限公司旗下的轴承和密封件业务转移到建和私人有限公司
- 2015** Set up new branch in Ubi, Central Singapore
在新加坡中部乌美设立分行
- 2019** Awarded bizSAFE Level 1
获得商业安全1级认证
The Holding Company was privatised and renamed as Raffles United Holdings Pte Ltd on 30 December
母公司莱佛士联合控股有限公司于2019年12月30日全面私有化，并改名为莱佛士联合控股私人有限公司
- 2020** Awarded bizSAFE Level 2 and 3
获得商业安全2级与3级认证
- 2021** Acquired authorised distributorship for Hallite seals in PT. Kian Ho Indonesia
建和印尼获得Hallite的代理商授权
- 2022** Upgraded as Primary Distributor of KURODA Precision ball screws in South East Asia and China
升级为KURODA精密滚珠丝杠在东南亚和中国的一级经销商
- 2023** Acquired authorised distributorship for China UBC bearings in South East Asia and China
取得中国UBC轴承在东南亚及中国的代理商授权
Acquired authorised distributorship for Sakaguchi Electric Heaters from Japan for South East Asia and China
取得坂口电热株式会社在东南亚和中国的经销权
- 2024** Established a subsidiary, United Automation Co., Ltd in Thailand
在泰国设立子公司:联合自动化有限公司
Acquired authorised distributorship for AirTAC pneumatic products from Taiwan for South East Asia
获得台湾亚德客在东南亚的代理商授权
Acquired authorised distributorship for WON ST shaft products from South Korea for South East Asia and China
获得韩国万思特在东南亚和中国的代理商授权
- 2025** Acquired exclusive distributorship for China HZF Bearings in South East Asia
取得中国兆丰轴承在东南亚的独家经销权
- 2026** Upgraded as Premier Distributor of Hallite seals
升级为Hallite的一级经销商



KIAN HO GROUP

OUR GROUP COMPANIES 我们的集团公司

SINGAPORE HEAD OFFICE

Raffles United Holdings Pte Ltd
Kian Ho Bearings Holdings Pte Ltd
Kian Ho Pte Ltd
5 Changi South Street 3
Singapore 486117
Tel: (65) 6287 5866
Fax: (65) 6545 4517
<https://www.kianho.com.sg>
enquiry@kianho.com.sg

Branches

27A Jurong Port Road
#01-42 Singapore 619101
Tel: (65) 6268 3410/1

3024 Ubi Road 3
#01-57 Singapore 408652
Tel: (65) 6299 3988

VIETNAM

Kian Ho (Vietnam) Co., Ltd

Ho Chi Minh

100, Street 218 Cao Lo
Chanh Hung Ward
Ho Chi Minh City
Tel: (84) 28 3852 0866
Fax: (84) 28 3852 0886
info@kianho.com.vn

Bac Ninh

37 Nguyen Huu Nghiem
Area 2 Kinh Bac Ward
Bac Ninh City
Tel: (84) 222 355 6337

MALAYSIA

Kian Ho Bearings (M) Sdn Bhd

Kuala Lumpur

Modules 0009-0011
Kompleks Sentral
33, Jalan Segambut Atas
51200 Kuala Lumpur
Tel: (60) 3 6251 8828
Fax: (60) 3 6251 8818
khmoem@khm.com.my

Johor Bahru

43 Jalan Glasiar Taman Tasek
80200 Johor Bahru
Tel: (60) 7 237 2288
Fax: (60) 7 237 4996

Kluang

61, 63 Jalan Lim Swee Sim
Kluang Bahru
86000 Kluang
Tel: (60) 7 772 1636, 772 8922
Fax: (60) 7 772 8921

Penang

134 Jalan Tasek Mutiara 2
Bandar Tasek Mutiara
14120 Simpang Ampat
Pulau Pinang
Tel: (60) 4 398 8828
Fax: (60) 4 398 6618

THAILAND

United Automation Co., Ltd

Bangkok

846/2, Bldg. A2, 2nd floor
Unit A224, Lasalle Road
Bangna Tai, Bangna
Bangkok 10260
Tel: (66) 2 115 9399
enquiry@unitedautomation.co.th

INDONESIA

PT. Kian Ho Indonesia

Jakarta

Bizpark Commercial Estate
Blok A5 No. 25
Cakung, Jakarta Timur 13920
Tel: (62) 21 461 4084
enquiry@kianho.co.id

Batam

Ruko Bandara Mas Blok B
No.8 Kelurahan Belian
Kecamatan Batam Kota
Kota Batam
Tel: (62) 778 416 9858

CHINA

Acker Machinery (Shanghai) Co., Ltd

Shanghai

Tian Mu Zhong Road
267, 5th Floor
The Sapphire Tower
Shanghai
Tel: (86) 21 5187 6293
Fax: (86) 21 5101 5836
sales@kianho.com.cn

Hong Kong

Kian Ho (H.K.) Company Limited

