

ROLLER BEARINGS

- Caged Roller Bearings
- Full Complement Roller Bearings
- Roller Bearings for Sheaves

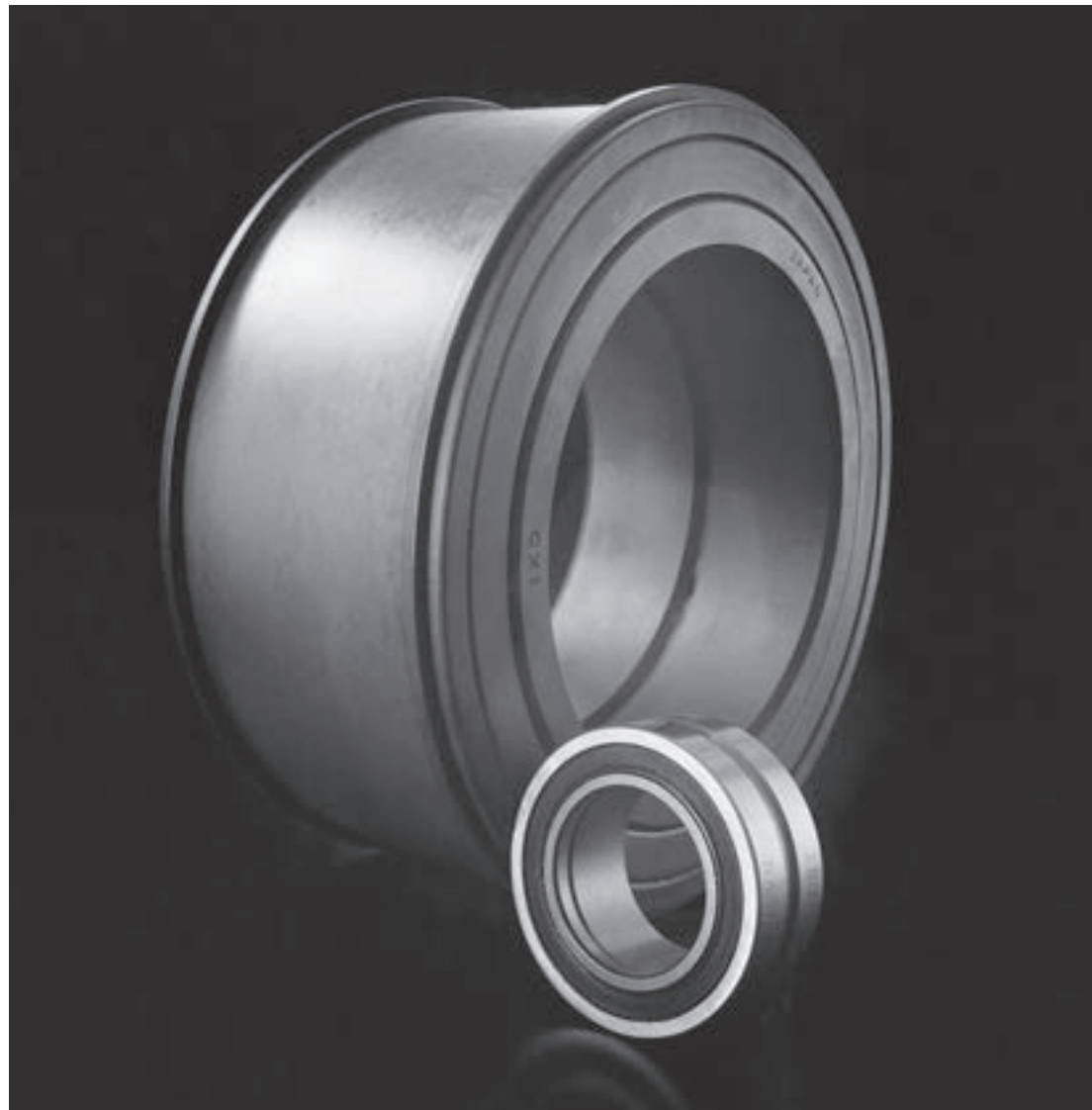

Structure and Features

IKO Roller Bearings in which rollers are incorporated in two rows are non-separable heavy-duty bearings. They can withstand not only radial loads but axial loads as well, which are supported at the contacts between the shoulders of inner and outer rings and the end faces of rollers. Therefore, they are most suitable for use at the fixing side of a shaft. Like needle roller bearings, they are also compact. Roller bearings include the caged type, full complement type and the type for sheaves, and any bearings suitable for the operating conditions can be selected. In particular, these bearings are used for heavy-duty machines such as construction machinery, and industrial machinery.

Structures of Roller Bearings

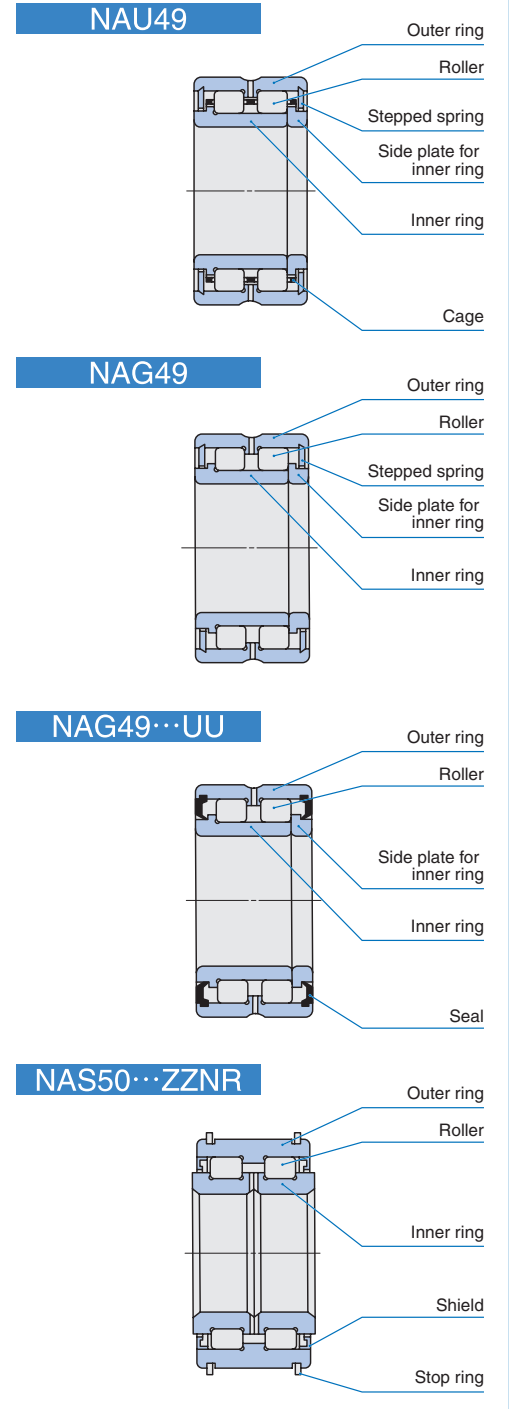

Types

The types of Roller Bearings shown in Table 1 are available.

Table 1 Type of bearing

Type	Caged type	Full complement type	For sheaves
Standard	NAU49 TRU	NAG49	—
With seal	NAU49...UU TRU...UU	NAG49...UU	NAS50...UUNR
With shield	—	—	NAS50...ZZNR

Caged Roller Bearings

These bearings are suitable for high-speed rotations and fluctuating loads. Also, as the axial distance between the double-row rollers is comparatively large, large moment loads can be supported.

Caged roller bearings with seal incorporate seals on both sides. Synthetic resin rubber seals are excellent in the prevention of dust penetration and grease leakage, providing an excellent sealing effect.

Full Complement Roller Bearings

These bearings are suitable for low-speed rotations or oscillating motions and heavy loads. Similar to the caged type, the structure is advantageous for supporting moment loads.

The bearings with seal incorporate seals on both sides.

Roller Bearings for Sheaves

These bearings are the double-row full complement type with a low sectional height designed for use in sheaves. There are two types; the sealed type and the shield type. They can withstand heavy radial loads and shock loads at comparatively low-speed rotations, and can also withstand axial loads.

They can easily be fixed axially to sheaves using the stop rings of the outer ring. As the width of the inner ring is designed to be larger than that of the outer ring, they require no spacer between sheaves. The structure is stable because the double-row rollers can withstand the moment loads caused by rope transition.

The surfaces of these bearings are treated to have high corrosion resistance.

Identification Number

The identification number of Roller Bearings consists of a model code, dimensions, any supplemental codes and a classification symbol. The arrangement examples are shown below.

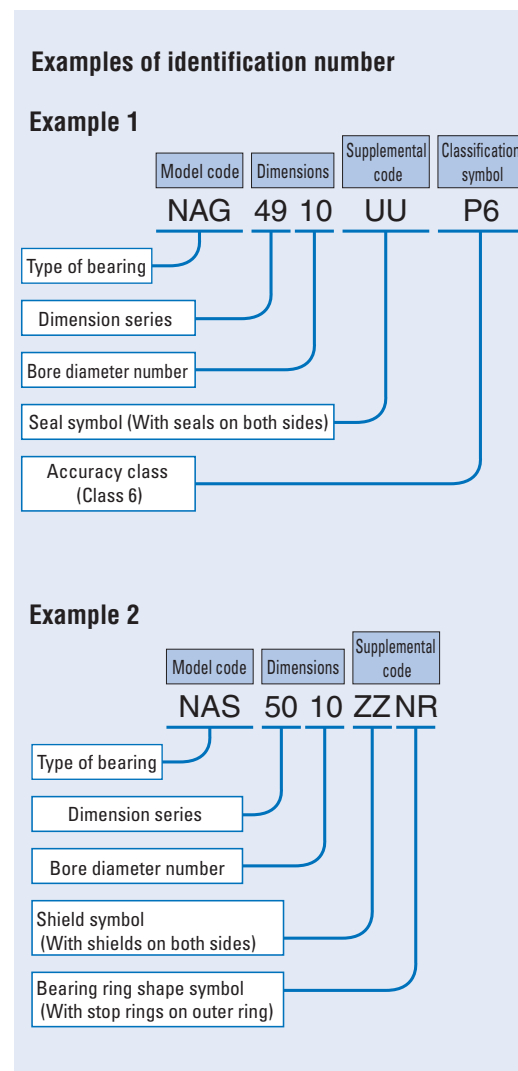

Accuracy

Roller Bearings are manufactured in accordance with JIS (See page A31.). A side plate for inner ring is assembled on one side of caged or full complement roller bearings. The tolerance of bore diameter of the side plate is shown below. Tolerances of Roller Bearings for Sheaves represent the values before surface treatment. The tolerance of internal distance between cir-clips is shown below.

Tolerance of bore diameter of the side plate d : E7
Tolerance of internal distance between cir-clips C_1 : 0~+0.4mm

Clearance

Roller Bearings are manufactured to the CN clearance shown in Table 18 on page A37. However, Roller Bearings for Sheaves are manufactured so that proper operating clearances are obtained after being mounted with a specified fit.

Fit

The recommended fits for Roller Bearings are shown in Tables 21 to 22 on pages A41 and A42. The recommended fits for Roller Bearings for Sheaves are shown in Table 2.

Table 2 Recommended fits for Roller Bearings for Sheaves

Tolerance class of shaft	Tolerance class of housing bore
g6	N7

Table 3 Bearings with prepacked grease

○ : With prepacked grease × : Without prepacked grease

Type	Standard	With seals	With shields
Caged type	NAU, TRU	×	○
Full complement type	NAG	×	○
For sheaves	NAS	—	○

Table 4 Number of oil holes of the inner ring and outer ring

Type	Nominal bore diameter d mm	Number of oil holes of the outer ring			Number of oil holes of the inner ring
		Standard	With seals	With shields	
Caged type	$d \leq 17$	0	0	—	0
	$17 < d$	2	2	—	
Full complement type	$d \leq 17$	0	0	—	0
	$17 < d$	2	2	—	
For sheaves	NAS	—	0	0	2

Remark The bearings with oil holes are also provided with an oil groove.

Lubrication

Bearings with prepacked grease are shown in Table 3. For Caged Roller Bearings and Full Complement Roller Bearings, ALVANIA GREASE S2 (Shell Lubricants Japan K.K.) is prepacked as the lubricating grease. For Roller Bearings for Sheaves, ALVANIA GREASE EP2 (Shell Lubricants Japan K.K.) is prepacked as the lubricating grease.

In the case of bearings without prepacked grease, perform proper lubrication for use. Operating without lubrication will increase the wear of the rolling contact surfaces and shorten their lives.

Oil Hole

The number of oil holes of the inner and outer rings is shown in Table 4.

Operating Temperature Range

The operating temperature range for Roller Bearings is $-20^{\circ}\text{C} \sim +120^{\circ}\text{C}$. However, the maximum allowable temperature for Roller Bearings for Sheaves is $+110^{\circ}\text{C}$.

Axial Load Capacity

Axial load capacity is not determined from the basic dynamic load rating based on rolling fatigue, but is determined by the amount of heat generated by sliding contact between the ends of rollers and guide shoulders of the inner and outer rings. It is therefore limited by the load conditions, sliding speeds, lubrication methods, etc.

The axial load capacity of Roller Bearings is obtained from the following equation.

If the axial load increases in comparison with the radial load, it will start to interfere with the smooth rolling motion. The axial load should therefore be within 20% of the radial load.

$$C_A = f_v a f_A \dots\dots\dots (1)$$

where, C_A : Axial load capacity N

f_v : Speed correction factor

f_v is obtained from Fig.2 by calculating the $d_m n$ value.

$$d_m n = d_m \times n$$

d_m : Mean value of bearing bore and outside diameters mm

$$\left(d_m \doteq \frac{d + D}{2} \right)$$

n : Rotational speed min^{-1}

When $d_m n \leq 1000$, $f_v = 1$.

a : Value determined by type of bearing (See Table 5.)

f_A : Axial load capacity factor (See Fig.1.)

Table 5 Value by type of bearing

Type of bearing	a
NAS 50	1
NAG 49	0.78
NAU 49, TRU	0.7

Calculation example

When a roller bearing for sheaves NAS 5016 ZZ NR is run at $n = 250 \text{ min}^{-1}$ under grease lubrication and subjected to an intermittent axial load, the axial load capacity is calculated as follows.

As the bearing bore diameter is 80 mm, $f_A = 18000$ is obtained from the axial load capacity line of Fig. 1 (ii).

$$a = 1$$

$$d_m \doteq \frac{80 + 125}{2} = 102.5$$

$$d_m n = 102.5 \times 250 \doteq 25600$$

From Fig. 2, $f_v \doteq 0.87$

Therefore, the axial load capacity C_A is obtained.

$$C_A = f_v a f_A = 0.87 \times 1 \times 18000 \doteq 15700 \text{ N}$$

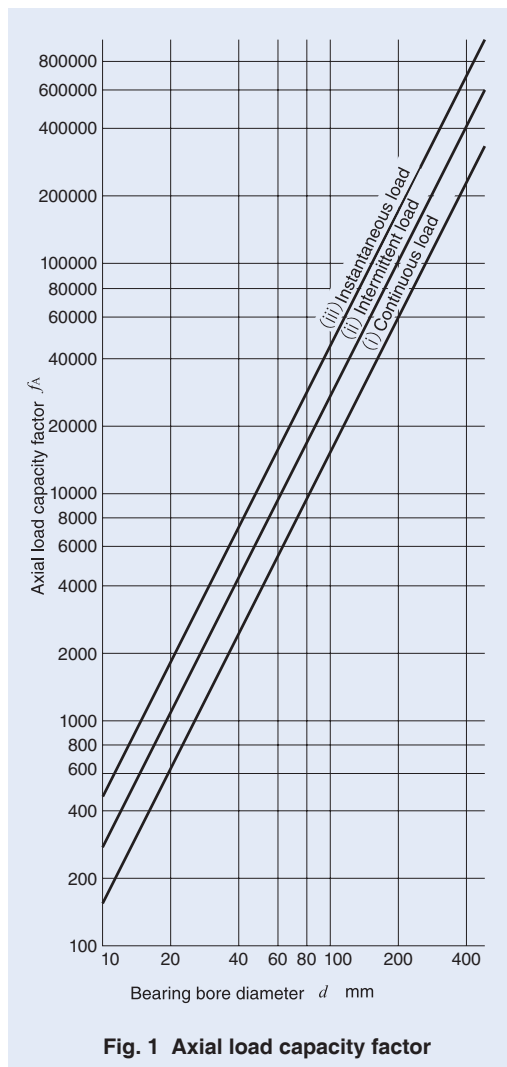

Fig. 1 Axial load capacity factor

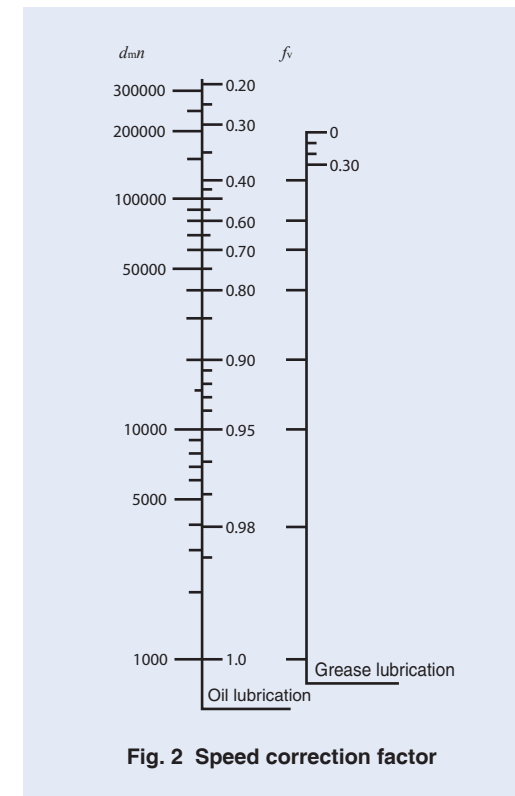

Fig. 2 Speed correction factor

Mounting

Unlike needle roller bearings, Caged and Full Complement Roller Bearings are non-separable.

As shown in Fig. 3 (1), the inner ring should be press-fitted until it makes close contact with the shaft shoulder, and fixed axially with a nut. Dimensions of the shoulders of the shaft and housing should be based on J and E_W shown in the table of dimensions, respectively.

In the case of Roller Bearings for Sheaves, as shown in Fig. 3 (2), the outer ring should be fixed by stop rings after being press-fitted into the sheaves, and the inner ring should be fixed securely in the axial direction.

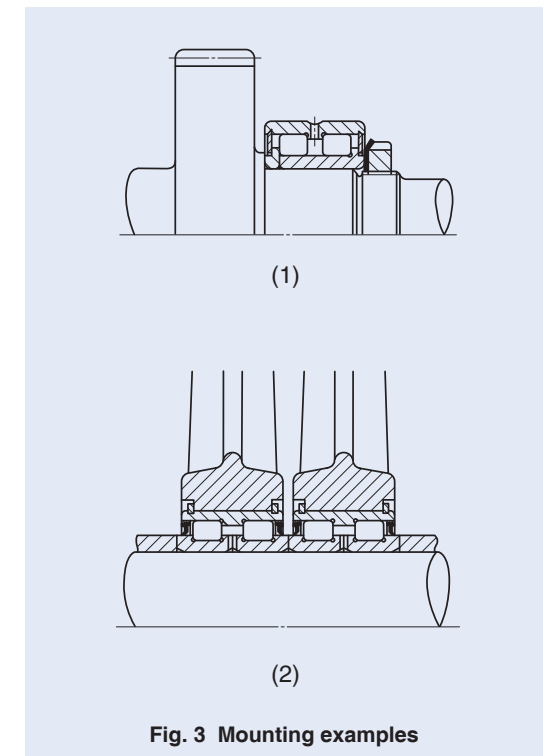
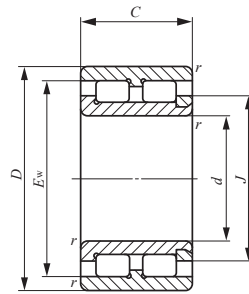

Fig. 3 Mounting examples

E
NAG
NAU
TRU
NAS

ROLLER BEARINGS

Caged Roller Bearings
Full Complement Roller Bearings



NAG49
($d \leq 17$)

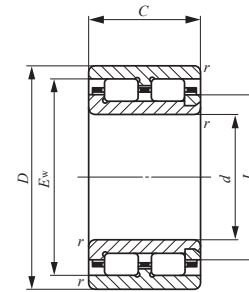

NAU49
($d \leq 17$)

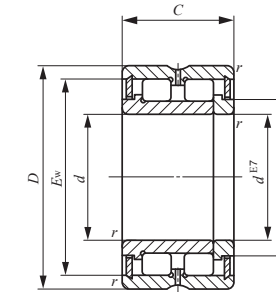

NAG49

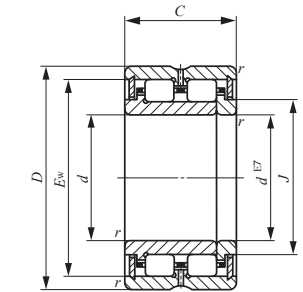

NAU49 TRU

Shaft dia. 10 – 35mm

Shaft dia. mm	Identification number			Mass (Ref.) g	Boundary dimensions mm					
	Full complement type	Caged type			d	D	C	r_s min ⁽¹⁾	J	E_w
10	NAG 4900	—	—	25.5	10	22	13	0.3	15.5	18.5
	—	NAU 4900	—	24.5	10	22	13	0.3	15.5	18.5
12	NAG 4901	—	—	28.5	12	24	13	0.3	17	20
	—	NAU 4901	—	27.5	12	24	13	0.3	17	20
15	NAG 4902	—	—	38	15	28	13	0.3	21	24
	—	NAU 4902	—	36.5	15	28	13	0.3	21	24
	—	—	TRU 153320	80.5	15	33	20	0.3	19.5	27
17	NAG 4903	—	—	41	17	30	13	0.3	22.5	25.5
	—	NAU 4903	—	39.5	17	30	13	0.3	22.5	25.5
	—	—	TRU 173425	100	17	34	25	0.3	21.5	29.5
20	NAG 4904	—	—	76.5	20	37	17	0.3	24	31.5
	—	NAU 4904	—	76	20	37	17	0.3	24	31.5
	—	—	TRU 203820	96.5	20	38	20	0.3	25	32.5
	—	—	TRU 203825	122	20	38	25	0.3	25	32.5
25	NAG 4905	—	—	89.5	25	42	17	0.3	29.5	37
	—	NAU 4905	—	89	25	42	17	0.3	29.5	37
	—	—	TRU 254425	154	25	44	25	0.3	30.5	38
28	—	—	TRU 284530	173	28	45	30	0.3	31.5	39.5
30	NAG 4906	—	—	103	30	47	17	0.3	34	41.5
	—	NAU 4906	—	102	30	47	17	0.3	34	41.5
	—	—	TRU 304830	197	30	48	30	0.3	35	42.5
32	—	—	TRU 325230	260	32	52	30	0.6	38	46
35	NAG 4907	—	—	172	35	55	20	0.6	40	49
	—	NAU 4907	—	168	35	55	20	0.6	40	49
	—	—	TRU 355630	270	35	56	30	0.6	40	49

Notes⁽¹⁾ Minimum allowable value of chamfer dimension r
⁽²⁾ Allowable rotational speed applies to oil lubrication. For grease lubrication, a maximum of 60% of this value is allowable. Considering that the axial load acts under practical operating conditions, up to 1/10 of this value is recommended for actual use.
 Remarks1. The NAG and NAU series with a bore diameter d of 17 mm or less have no oil hole. In others, the outer ring has an oil groove and two oil holes.
 2. No grease is prepacked. Perform proper lubrication.

Basic dynamic load rating C N	Basic static load rating C_0 N	Allowable rotational speed ⁽²⁾ min ⁻¹
9 650	10 800	17 000
6 580	6 470	30 000
10 300	12 000	15 000
6 950	7 120	25 000
11 800	15 200	12 000
7 950	9 020	20 000
10 400	10 400	20 000
12 300	16 500	11 000
8 240	9 670	19 000
18 000	21 600	18 000
15 600	18 900	9 500
10 700	11 300	16 000
12 100	13 400	16 000
18 700	23 600	16 000
17 500	23 200	7 500
11 900	13 900	13 000
21 000	28 900	13 000
28 700	43 800	12 000
19 400	27 600	6 500
13 000	16 200	12 000
29 400	46 600	11 000
29 800	44 200	10 000
28 700	43 800	5 500
19 500	26 300	10 000
32 200	49 800	10 000

E
NAG
NAU
TRU
NAS

ROLLER BEARINGS

Caged Roller Bearings
Full Complement Roller Bearings



Shaft dia. 40 – 80mm

Shaft dia. mm	Identification number			Mass (Ref.) g	Boundary dimensions mm					
	Full complement type	Caged type			<i>d</i>	<i>D</i>	<i>C</i>	<i>r_{s min}</i> ⁽¹⁾	<i>J</i>	<i>E_w</i>
40	NAG 4908	—	—	225	40	62	22	0.6	46	56
	—	—	TRU 405930	265	40	59	30	0.6	45	52.5
	—	NAU 4908	—	220	40	62	22	0.6	46	56
42	—	—	TRU 426230	290	42	62	30	0.6	48	56.5
45	NAG 4909	—	—	265	45	68	22	0.6	51	61
	—	—	TRU 456430	295	45	64	30	0.6	50.5	58.5
	—	NAU 4909	—	260	45	68	22	0.6	51	61
50	NAG 4910	—	—	270	50	72	22	0.6	55.5	65.5
	—	NAU 4910	—	265	50	72	22	0.6	55.5	65.5
	—	—	TRU 507745	710	50	77	45	1	58	69
55	NAG 4911	—	—	395	55	80	25	1	61.5	72.5
	—	NAU 4911	—	385	55	80	25	1	61.5	72.5
	—	—	TRU 558138	615	55	81	38	1	61.5	72.5
60	NAG 4912	—	—	425	60	85	25	1	67	77.5
	—	NAU 4912	—	415	60	85	25	1	67	77.5
	—	—	TRU 608945	880	60	89	45	1	69.5	81.5
65	NAG 4913	—	—	455	65	90	25	1	72	83
	—	NAU 4913	—	440	65	90	25	1	72	83
70	NAG 4914	—	—	725	70	100	30	1	79	91.5
	—	NAU 4914	—	705	70	100	30	1	79	91.5
75	NAG 4915	—	—	775	75	105	30	1	83.5	95.5
	—	NAU 4915	—	750	75	105	30	1	83.5	95.5
	—	—	TRU 7510845	1 240	75	108	45	1	85.5	98.5
80	NAG 4916	—	—	815	80	110	30	1	89.5	102
	—	NAU 4916	—	790	80	110	30	1	89.5	102

Notes⁽¹⁾ Minimum allowable value of chamfer dimension *r*
⁽²⁾ Allowable rotational speed applies to oil lubrication. For grease lubrication, a maximum of 60% of this value is allowable. Considering that the axial load acts under practical operating conditions, up to 1/10 of this value is recommended for actual use.

- Remarks1. The outer ring has an oil groove and two oil holes.
 2. No grease is prepacked. Perform proper lubrication.

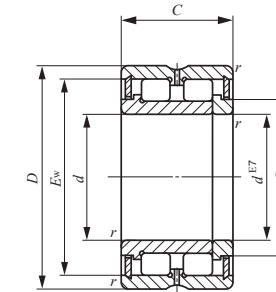

NAG49

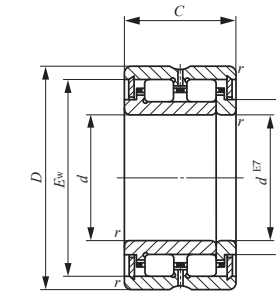

NAU49 TRU

Basic dynamic load rating <i>C</i> N	Basic static load rating <i>C₀</i> N	Allowable rotational speed ⁽²⁾ min ⁻¹
34 600	49 500	5 000
34 700	62 500	8 500
23 400	29 400	8 500
34 600	57 800	8 000
36 400	54 700	4 500
32 600	59 700	8 000
24 800	32 800	8 000
38 200	59 900	4 000
26 200	36 200	7 000
75 700	134 000	7 000
48 100	77 700	3 500
33 000	47 000	6 500
61 400	104 000	6 500
50 300	84 300	3 500
34 700	51 400	6 000
88 100	152 000	6 000
53 200	93 000	3 000
36 900	57 100	5 500
77 700	139 000	3 000
53 700	84 600	5 000
80 000	146 000	2 500
54 800	88 200	5 000
103 000	190 000	4 500
83 000	157 000	2 500
57 200	95 500	4 500

E
NAG
NAU
TRU
NAS

ROLLER BEARINGS

Caged Roller Bearings
Full Complement Roller Bearings



Shaft dia. 85 – 140mm

Shaft dia. mm	Identification number			Mass (Ref.) g	Boundary dimensions mm					
	Full complement type	Caged type			<i>d</i>	<i>D</i>	<i>C</i>	⁽¹⁾ <i>r_{s min}</i>	<i>J</i>	<i>E_w</i>
85	NAG 4917	—	—	1 190	85	120	35	1.5	96	110
	—	—	TRU 8511850	1 530	85	118	50	1	94.5	107.5
	—	NAU 4917	—	1 150	85	120	35	1.5	96	110
	—	—	TRU 8512045	1 500	85	120	45	1.5	96.5	110
90	NAG 4918	—	—	1 250	90	125	35	1.5	101	115.5
	—	NAU 4918	—	1 210	90	125	35	1.5	101	115.5
	—	—	TRU 9012550	1 740	90	125	50	1.5	101	114
95	NAG 4919	—	—	1 300	95	130	35	1.5	106	120.5
	—	NAU 4919	—	1 270	95	130	35	1.5	106	120.5
100	NAG 4920	—	—	1 850	100	140	40	1.5	114.5	129.5
	—	—	TRU 10013550	1 900	100	135	50	1.5	112	125.5
	—	NAU 4920	—	1 770	100	140	40	1.5	114.5	129.5
105	—	—	TRU 10515350	2 890	105	153	50	1.5	120	138
110	NAG 4922	—	—	2 010	110	150	40	1.5	123	138.5
	—	NAU 4922	—	1 930	110	150	40	1.5	123	138.5
120	NAG 4924	—	—	2 780	120	165	45	1.5	136	153.5
	—	NAU 4924	—	2 680	120	165	45	1.5	136	153.5
125	—	—	TRU 12517860	4 490	125	178	60	1.5	143.5	162
130	NAG 4926	—	—	3 750	130	180	50	2	147	165.5
	—	NAU 4926	—	3 610	130	180	50	2	147	165.5
135	—	—	TRU 13518860	4 790	135	188	60	1.5	154	172.5
140	NAG 4928	—	—	3 990	140	190	50	2	157.5	176
	—	NAU 4928	—	3 840	140	190	50	2	157.5	176

Notes⁽¹⁾ Minimum allowable value of chamfer dimension *r*
⁽²⁾ Allowable rotational speed applies to oil lubrication. For grease lubrication, a maximum of 60% of this value is allowable. Considering that the axial load acts under practical operating conditions, up to 1/10 of this value is recommended for actual use.
 Remarks1. The outer ring has an oil groove and two oil holes.
 2. No grease is prepacked. Perform proper lubrication.

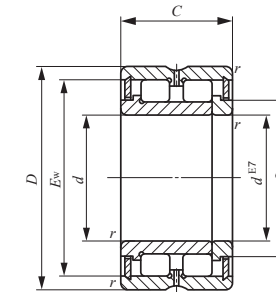

NAG49

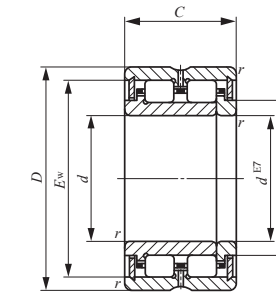

NAU49 TRU

Basic dynamic load rating <i>C</i> N	Basic static load rating <i>C₀</i> N	Allowable rotational speed ⁽²⁾ min ⁻¹
111 000	200 000	2 500
114 000	222 000	4 000
75 400	120 000	4 000
110 000	215 000	4 000
114 000	211 000	2 500
79 500	130 000	4 000
119 000	240 000	4 000
117 000	222 000	2 000
81 000	136 000	4 000
152 000	292 000	2 000
124 000	264 000	3 500
106 000	181 000	3 500
159 000	286 000	3 500
161 000	322 000	1 900
113 000	200 000	3 500
208 000	431 000	1 700
146 000	268 000	3 000
211 000	408 000	3 000
240 000	495 000	1 600
166 000	304 000	2 500
220 000	442 000	2 500
249 000	531 000	1 500
174 000	327 000	2 500

ROLLER BEARINGS

Caged Roller Bearings With Seal

Full Complement Roller Bearings With Seal



Shaft dia. 10 – 40mm

Shaft dia. mm	Identification number			Mass (Ref.) g	Boundary dimensions mm				
	Full complement type	Caged type			<i>d</i>	<i>D</i>	<i>C</i>	<i>r_s</i> min ⁽¹⁾	<i>J</i>
10	NAG 4900UU	—	—	25.5	10	22	13	0.3	15.5
12	NAG 4901UU	—	—	28.5	12	24	13	0.3	17
15	NAG 4902UU	—	—	38	15	28	13	0.3	21
	—	—	TRU 153320UU	80.5	15	33	20	0.3	19.5
17	NAG 4903UU	—	—	41	17	30	13	0.3	22.5
	—	—	TRU 173425UU	100	17	34	25	0.3	21.5
20	NAG 4904UU	—	—	76.5	20	37	17	0.3	24
	—	NAU 4904UU	—	76	20	37	17	0.3	24
	—	—	TRU 203820UU	96.5	20	38	20	0.3	25
	—	—	TRU 203825UU	122	20	38	25	0.3	25
25	NAG 4905UU	—	—	89.5	25	42	17	0.3	29.5
	—	NAU 4905UU	—	89	25	42	17	0.3	29.5
	—	—	TRU 254425UU	154	25	44	25	0.3	30.5
28	—	—	TRU 284530UU	173	28	45	30	0.3	31.5
30	NAG 4906UU	—	—	103	30	47	17	0.3	34
	—	NAU 4906UU	—	102	30	47	17	0.3	34
	—	—	TRU 304830UU	197	30	48	30	0.3	35
32	—	—	TRU 325230UU	260	32	52	30	0.6	38
35	NAG 4907UU	—	—	172	35	55	20	0.6	40
	—	NAU 4907UU	—	168	35	55	20	0.6	40
	—	—	TRU 355630UU	270	35	56	30	0.6	40
40	NAG 4908UU	—	—	225	40	62	22	0.6	46
	—	—	TRU 405930UU	265	40	59	30	0.6	45
	—	NAU 4908UU	—	220	40	62	22	0.6	46

Notes⁽¹⁾ Minimum allowable value of chamfer dimension *r*

⁽²⁾ Allowable rotational speed applies to grease lubrication. Considering that the axial load acts under practical operating conditions, up to 1/10 of this value is recommended for actual use.

Remarks1. The NAG and NAU series with a bore diameter, *d*, of 17 mm or less have no oil hole. In others, the outer ring has an oil groove and two oil holes.

2. The bearings with seals are provided with prepacked grease.

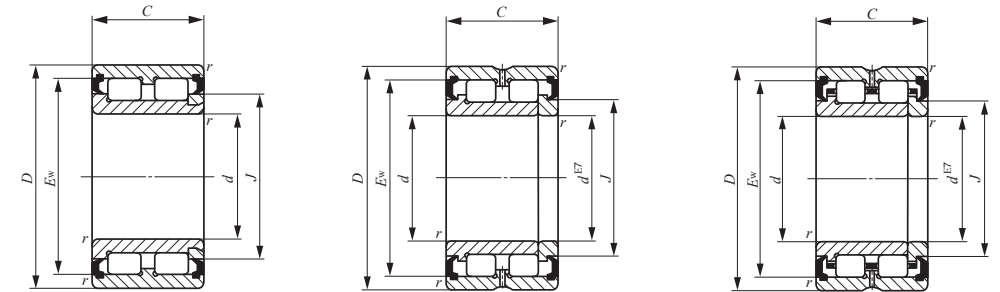

NAG49 ... UU
(*d* ≤ 17)

NAG49 ... UU

NAU49 ... UU
TRU ... UU

<i>E_w</i>	Basic dynamic load rating <i>C</i> N	Basic static load rating <i>C₀</i> N	Allowable rotational speed ⁽²⁾ min ⁻¹
19.5	9 650	10 800	10 000
21	10 300	12 000	9 000
25	11 800	15 200	7 000
27	10 400	10 400	9 500
26.5	12 300	16 500	6 500
29.5	18 000	21 600	8 500
31.5	15 600	18 900	5 500
31.5	10 700	11 300	8 000
32.5	12 100	13 400	7 500
32.5	18 700	23 600	7 500
37	17 500	23 200	4 500
37	11 900	13 900	6 500
38	21 000	28 900	6 000
39.5	28 700	43 800	6 000
41.5	19 400	27 600	4 000
41.5	13 000	16 200	5 500
42.5	29 400	46 600	5 500
46	29 800	44 200	5 000
49	28 700	43 800	3 500
49	19 500	26 300	4 500
49	32 200	49 800	4 500
56	34 600	49 500	3 000
52.5	34 700	62 500	4 000
56	23 400	29 400	4 000

ROLLER BEARINGS

Caged Roller Bearings **With Seal**
 Full Complement Roller Bearings **With Seal**



Shaft dia. 42 – 80mm

Shaft dia. mm	Identification number			Mass (Ref.) g	Boundary dimensions mm				
	Full complement type	Caged type			<i>d</i>	<i>D</i>	<i>C</i>	<i>r_s</i> min ⁽¹⁾	<i>J</i>
42	—	—	TRU 426230UU	290	42	62	30	0.6	48
45	NAG 4909UU	—	—	265	45	68	22	0.6	51
	—	—	TRU 456430UU	295	45	64	30	0.6	50.5
	—	NAU 4909UU	—	260	45	68	22	0.6	51
50	NAG 4910UU	—	—	270	50	72	22	0.6	55.5
	—	NAU 4910UU	—	265	50	72	22	0.6	55.5
	—	—	TRU 507745UU	710	50	77	45	1	58
55	NAG 4911UU	—	—	395	55	80	25	1	61.5
	—	NAU 4911UU	—	385	55	80	25	1	61.5
	—	—	TRU 558138UU	615	55	81	38	1	61.5
60	NAG 4912UU	—	—	425	60	85	25	1	67
	—	NAU 4912UU	—	415	60	85	25	1	67
	—	—	TRU 608945UU	880	60	89	45	1	69.5
65	NAG 4913UU	—	—	455	65	90	25	1	72
	—	NAU 4913UU	—	440	65	90	25	1	72
70	NAG 4914UU	—	—	725	70	100	30	1	79
	—	NAU 4914UU	—	705	70	100	30	1	79
75	NAG 4915UU	—	—	775	75	105	30	1	83.5
	—	NAU 4915UU	—	750	75	105	30	1	83.5
	—	—	TRU 7510845UU	1 240	75	108	45	1	85.5
80	NAG 4916UU	—	—	815	80	110	30	1	89.5
	—	NAU 4916UU	—	790	80	110	30	1	89.5

Notes⁽¹⁾ Minimum allowable value of chamfer dimension *r*
⁽²⁾ Allowable rotational speed applies to grease lubrication. Considering that the axial load acts under practical operating conditions, up to 1/10 of this value is recommended for actual use.
 Remarks1. The outer ring has an oil groove and two oil holes.
 2. The bearings with seals are provided with prepacked grease.

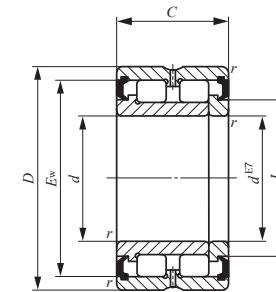

NAG49 ... UU

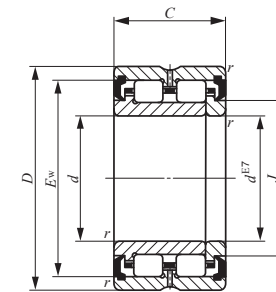

NAU49 ... UU
 TRU ... UU

<i>E_w</i>	Basic dynamic load rating <i>C</i> N	Basic static load rating <i>C₀</i> N	Allowable rotational speed ⁽²⁾ min ⁻¹
56.5	34 600	57 800	4 000
61	36 400	54 700	2 500
58.5	32 600	59 700	3 500
61	24 800	32 800	3 500
65.5	38 200	59 900	2 500
65.5	26 200	36 200	3 500
69	75 700	134 000	3 500
72.5	48 100	77 700	2 000
72.5	33 000	47 000	3 000
72.5	61 400	104 000	3 000
77.5	50 300	84 300	2 000
77.5	34 700	51 400	3 000
81.5	88 100	152 000	3 000
83	53 200	93 000	1 900
83	36 900	57 100	2 500
91.5	77 700	139 000	1 800
91.5	53 700	84 600	2 500
95.5	80 000	146 000	1 700
95.5	54 800	88 200	2 500
98.5	103 000	190 000	2 000
102	83 000	157 000	1 600
102	57 200	95 500	2 000

ROLLER BEARINGS

Caged Roller Bearings With Seal

Full Complement Roller Bearings With Seal



Shaft dia. 85 – 140mm

Shaft dia. mm	Identification number			Mass (Ref.) g	Boundary dimensions mm				
	Full complement type	Caged type			<i>d</i>	<i>D</i>	<i>C</i>	<i>r_s</i> min ⁽¹⁾	<i>J</i>
85	NAG 4917UU	—	—	1 190	85	120	35	1.5	96
	—	—	TRU 8511850UU	1 530	85	118	50	1	94.5
	—	NAU 4917UU	—	1 150	85	120	35	1.5	96
	—	—	TRU 8512045UU	1 500	85	120	45	1.5	96.5
90	NAG 4918UU	—	—	1 250	90	125	35	1.5	101
	—	NAU 4918UU	—	1 210	90	125	35	1.5	101
	—	—	TRU 9012550UU	1 740	90	125	50	1.5	101
95	NAG 4919UU	—	—	1 300	95	130	35	1.5	106
	—	NAU 4919UU	—	1 270	95	130	35	1.5	106
100	NAG 4920UU	—	—	1 850	100	140	40	1.5	114.5
	—	—	TRU 10013550UU	1 900	100	135	50	1.5	112
	—	NAU 4920UU	—	1 770	100	140	40	1.5	114.5
105	—	—	TRU 10515350UU	2 890	105	153	50	1.5	120
110	NAG 4922UU	—	—	2 010	110	150	40	1.5	123
	—	NAU 4922UU	—	1 930	110	150	40	1.5	123
120	NAG 4924UU	—	—	2 780	120	165	45	1.5	136
	—	NAU 4924UU	—	2 680	120	165	45	1.5	136
125	—	—	TRU 12517860UU	4 490	125	178	60	1.5	143.5
130	NAG 4926UU	—	—	3 750	130	180	50	2	147
	—	NAU 4926UU	—	3 610	130	180	50	2	147
135	—	—	TRU 13518860UU	4 790	135	188	60	1.5	154
140	NAG 4928UU	—	—	3 990	140	190	50	2	157.5
	—	NAU 4928UU	—	3 840	140	190	50	2	157.5

Notes⁽¹⁾ Minimum allowable value of chamfer dimension *r*
⁽²⁾ Allowable rotational speed applies to grease lubrication. Considering that the axial load acts under practical operating conditions, up to 1/10 of this value is recommended for actual use.
 Remarks1. The outer ring has an oil groove and two oil holes.
 2. The bearings with seals are provided with prepacked grease.

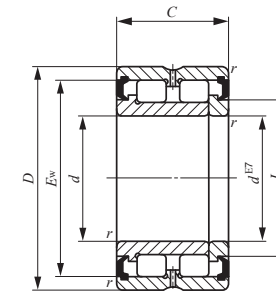

NAG49...UU

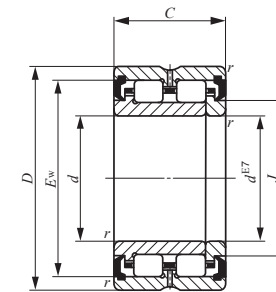

NAU49...UU
TRU...UU

<i>E_w</i>	Basic dynamic load rating <i>C</i> N	Basic static load rating <i>C₀</i> N	Allowable rotational speed ⁽²⁾ min ⁻¹
110	111 000	200 000	1 500
107.5	114 000	222 000	2 000
110	75 400	120 000	2 000
110	110 000	215 000	2 000
115.5	114 000	211 000	1 400
115.5	79 500	130 000	1 900
114	119 000	240 000	1 900
120.5	117 000	222 000	1 300
120.5	81 000	136 000	1 800
129.5	152 000	292 000	1 200
125.5	124 000	264 000	1 700
129.5	106 000	181 000	1 700
138	159 000	286 000	1 600
138.5	161 000	322 000	1 100
138.5	113 000	200 000	1 600
153.5	208 000	431 000	1 000
153.5	146 000	268 000	1 400
162	211 000	408 000	1 400
165.5	240 000	495 000	950
165.5	166 000	304 000	1 300
172.5	220 000	442 000	1 300
176	249 000	531 000	900
176	174 000	327 000	1 200

E
NAG
NAU
TRU
NAS

ROLLER BEARINGS

Roller Bearings for Sheaves



Shaft dia. 40 – 170mm

Shaft dia. mm	Identification number		Mass (Ref.) kg	Boundary dimensions mm						
	Sealed type	Shield type		<i>d</i>	<i>D</i>	<i>D</i> ₂	<i>B</i>	<i>C</i>	<i>C</i> ₁	<i>S</i>
40	NAS 5008UUNR	NAS 5008ZZNR	0.55	40	68	71.8	38	37	28	4.5
45	NAS 5009UUNR	NAS 5009ZZNR	0.70	45	75	78.8	40	39	30	4.5
50	NAS 5010UUNR	NAS 5010ZZNR	0.75	50	80	83.8	40	39	30	4.5
55	NAS 5011UUNR	NAS 5011ZZNR	1.15	55	90	94.8	46	45	34	5.5
60	NAS 5012UUNR	NAS 5012ZZNR	1.20	60	95	99.8	46	45	34	5.5
65	NAS 5013UUNR	NAS 5013ZZNR	1.30	65	100	104.8	46	45	34	5.5
70	NAS 5014UUNR	NAS 5014ZZNR	1.90	70	110	114.5	54	53	42	5.5
75	NAS 5015UUNR	NAS 5015ZZNR	2.00	75	115	119.5	54	53	42	5.5
80	NAS 5016UUNR	NAS 5016ZZNR	2.65	80	125	129.5	60	59	48	5.5
85	NAS 5017UUNR	NAS 5017ZZNR	2.80	85	130	134.5	60	59	48	5.5
90	NAS 5018UUNR	NAS 5018ZZNR	3.70	90	140	145.4	67	66	54	6
95	NAS 5019UUNR	NAS 5019ZZNR	3.90	95	145	150.4	67	66	54	6
100	NAS 5020UUNR	NAS 5020ZZNR	4.05	100	150	155.4	67	66	54	6
110	NAS 5022UUNR	NAS 5022ZZNR	6.50	110	170	175.4	80	79	65	7
120	NAS 5024UUNR	NAS 5024ZZNR	6.95	120	180	188.4	80	79	65	7
130	NAS 5026UUNR	NAS 5026ZZNR	10.5	130	200	208.4	95	94	77	8.5
140	NAS 5028UUNR	NAS 5028ZZNR	11.0	140	210	218.4	95	94	77	8.5
150	NAS 5030UUNR	NAS 5030ZZNR	13.5	150	225	233.4	100	99	81	9
160	NAS 5032UUNR	NAS 5032ZZNR	16.5	160	240	248.4	109	108	89	9.5
170	NAS 5034UUNR	NAS 5034ZZNR	22.5	170	260	270	122	121	99	11

Notes⁽¹⁾ Minimum allowable value of chamfer dimension *r*
⁽²⁾ Allowable rotational speed applies to grease lubrication. Considering that the axial load acts under practical operating conditions, up to 1/10 of this value is recommended for actual use.
 Remarks1. The inner ring has an oil groove and two oil holes.
 2. Roller Bearings for Sheaves are provided with prepacked grease.

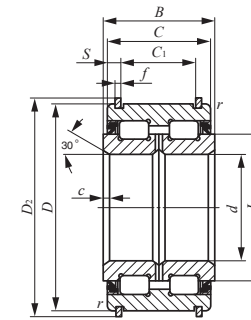

NAS50...UUNR

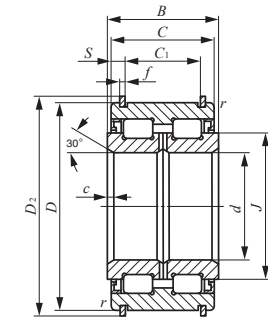

NAS50...ZZNR

<i>f</i>	<i>c</i>	<i>r</i> _{s min} ⁽¹⁾	<i>J</i>	Basic dynamic load rating	Basic static load rating	Allowable rotational speed ⁽²⁾ min ⁻¹
				<i>C</i> N	<i>C</i> ₀ N	
2	1.5	0.6	50	79 500	116 000	2 500
2	1.5	0.6	56	95 500	144 000	2 000
2	1.5	0.6	61	100 000	158 000	2 000
2.5	2	0.6	68	118 000	193 000	1 800
2.5	2	0.6	73	123 000	208 000	1 700
2.5	2	0.6	78	128 000	224 000	1 600
2.5	2	0.6	84	171 000	284 000	1 400
2.5	2	0.6	91	179 000	308 000	1 300
2.5	2	0.6	97	251 000	428 000	1 300
2.5	2	0.6	101	257 000	446 000	1 200
2.5	2.5	0.6	110	305 000	540 000	1 100
2.5	2.5	0.6	114	312 000	562 000	1 100
2.5	2.5	0.6	118	318 000	584 000	1 000
2.5	3	1	130	384 000	697 000	900
3	3	1	139.5	400 000	750 000	850
3	3	1	156	537 000	1 000 000	750
3	3	1	167	543 000	1 070 000	700
3	3.5	1	176.5	623 000	1 210 000	650
3	3.5	1.5	188.5	720 000	1 390 000	650
4	3.5	1.5	204.5	857 000	1 730 000	600

ROLLER BEARINGS

Roller Bearings for Sheaves



Shaft dia. 180 – 440mm

Shaft dia. mm	Identification number		Mass (Ref.) kg	Boundary dimensions mm						
	Sealed type	Shield type		<i>d</i>	<i>D</i>	<i>D</i> ₂	<i>B</i>	<i>C</i>	<i>C</i> ₁	<i>S</i>
180	NAS 5036UUNR	NAS 5036ZZNR	30.0	180	280	294	136	135	110	12.5
190	NAS 5038UUNR	NAS 5038ZZNR	31.5	190	290	306	136	135	110	12.5
200	NAS 5040UUNR	NAS 5040ZZNR	40.5	200	310	326	150	149	120	14.5
220	NAS 5044UUNR	NAS 5044ZZNR	52.0	220	340	356	160	159	130	14.5
240	NAS 5048UUNR	NAS 5048ZZNR	55.5	240	360	376	160	159	130	14.5
260	NAS 5052UUNR	NAS 5052ZZNR	85.0	260	400	416	190	189	154	17.5
280	NAS 5056UUNR	NAS 5056ZZNR	90.9	280	420	440	190	189	154	17.5

- Notes⁽¹⁾ Minimum allowable value of chamfer dimension *r*
⁽²⁾ Allowable rotational speed applies to grease lubrication. Considering that the axial load acts under practical operating conditions, up to 1/10 of this value is recommended for actual use.
 Remarks1. The inner ring has an oil groove and two oil holes.
 2. Roller Bearings for Sheaves are provided with prepacked grease.

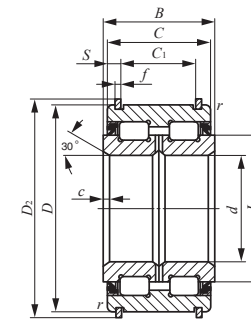

NAS50...UUNR

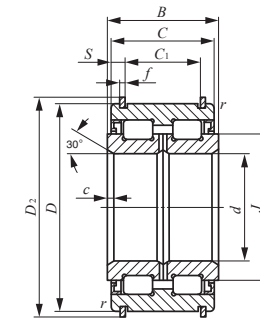

NAS50...ZZNR

<i>f</i>	<i>c</i>	<i>r</i> _{s min} ⁽¹⁾	<i>J</i>	Basic dynamic load rating	Basic static load rating	Allowable rotational speed ⁽²⁾ min ⁻¹
				<i>C</i> N	<i>C</i> ₀ N	
5	3.5	1.5	217	1 070 000	2 140 000	550
5	3.5	1.5	225	1 120 000	2 230 000	500
5	3.5	1.5	242	1 310 000	2 650 000	500
6	4	1.5	260	1 510 000	3 110 000	450
6	4	1.5	278.5	1 570 000	3 350 000	400
7	5	2	312	2 130 000	4 510 000	350
7	5	2	335	2 210 000	4 860 000	350

E
NAG
NAU
TRU
NAS